



# NovoCyte Quanteon Flow Cytometer

## Operator's Guide

***For Research Use Only. Not for use in diagnostic procedures.***





# Notices

## Manual Part Number

150135  
Third Edition, March 2021

## Copyright

© Agilent Technologies, Inc. 2021  
No part of this manual may be reproduced in any form or by any means (including electronic storage and retrieval or translation into a foreign language) without prior agreement and written consent from Agilent Technologies, Inc. as governed by United States and international copyright laws.

Agilent Technologies, Inc.  
6779 Mesa Ridge Road, Suite 100,  
San Diego, CA 92121, USA

## Operating Temperature

Operating Temperature: 15-32°C  
Storage Temperature: 1-40°C

## Warranty

The material contained in this document is provided "as is," and is subject to being changed, without notice, in future editions. Further, to the maximum extent permitted by applicable law, Agilent disclaims all warranties, either express or implied, with regard to this manual and any information contained herein, including but not limited to the implied warranties of merchantability and fitness for a particular purpose. Agilent shall not be liable for errors or for incidental or consequential damages in connection with the furnishing, use, or performance of this document or of any information contained herein. Should Agilent and the user have a separate written agreement with warranty terms covering the material in this document that conflict with these terms, the warranty terms in the separate agreement shall control.

## Technology Licenses

The hardware and/or software described in this document are furnished under a license and may be used or copied only in accordance with the terms of such license.

## Restricted Rights Legend

U.S. Government Restricted Rights. Software and technical data rights granted to the federal government include only those rights customarily provided to end user customers. Agilent provides this customary commercial license in Software and technical data pursuant to FAR 12.211 (Technical Data) and 12.212 (Computer Software) and, for the Department of Defense, DFARS 252.227-7015 (Technical Data - Commercial Items) and DFARS 227.7202-3 (Rights in Commercial Computer Software or Computer Software Documentation).

## Safety Notices

### CAUTION

A **CAUTION** notice denotes a hazard. It calls attention to an operating procedure, practice, or the like that, if not correctly performed or adhered to, could result in damage to the product or loss of important data. Do not proceed beyond a **CAUTION** notice until the indicated conditions are fully understood and met.

### WARNING

A **WARNING** notice denotes a hazard. It calls attention to an operating procedure, practice, or the like that, if not correctly performed or adhered to, could result in personal injury or death. Do not proceed beyond a **WARNING** notice until the indicated conditions are fully understood and met.

# In This Guide

This guide covers following module: NovoCyte Quanteon Flow Cytometer and associated standard accessories.

## 1 Prologue

This chapter describes the purpose and scope of this guide, symbols used in this guide, glossary, safety and limitations, Agilent regulatory compliance statement and technical support information.

## 2 Introduction

This chapter provides overview of NovoCyte Quanteon flow cytometer, including basic instrument operation principle, system requirements, and system components.

## 3 Installation

This chapter provides information on how to install NovoCyte Quanteon instrument and associated standard accessories, including installation warnings, space and environment requirements, instructions for lifting and carrying, and installation procedures.

## 4 Instrument Operation

This chapter provides the procedures to operate NovoCyte Quanteon flow cytometer, including instrument startup, verify and modify instrument configuration, instrument QC test, and instrument shutdown.

## 5 Running Samples

This chapter describes the typical procedures of running examples on NovoCyte Quanteon instrument using human peripheral blood lymphocyte subsets analysis as an example.

## 6 System Maintenance

This chapter describes the procedures to maintain NovoCyte Quanteon flow cytometer, including scheduled and unscheduled maintenance.

## 7 Troubleshooting

## **In This Guide**

This chapter describes general instrument troubleshooting and diagnostic guidelines.

## **8 Version History**

### **Appendix A: NovoCyte Quanteon Laser and Detection Channel Configuration**

This chapter provides additional information on NovoCyte Quanteon laser and detection channel configuration.

### **Appendix B: NovoCyte Quanteon Technical Specifications**

This chapter provides technical specifications of NovoCyte Quanteon flow cytometer and associated standard accessories.

# Contents

<b>In This Guide</b>	<b>3</b>
<b>Contents</b>	<b>5</b>
<b>1 Prologue</b>	<b>11</b>
Using this Guide	11
Symbols	11
Glossary	14
Safety and Limitations	16
General Safety	17
Ergonomics	19
Electrical Safety	20
Laser Safety	20
Laser Product Classification	21
Biosafety	21
Limitations	22
Agilent Regulatory Compliance Statement	23
CE Compliance	23
Electromagnetic Compatibility	23
EMC Declaration for South Korea	25
Detachable Power Cord Declaration for Japan	25
Sound Emission Certification for Federal Republic of Germany	25
Waste Electrical and Electronic Equipment (WEEE) Directive	25
Regulatory Compliance Identification Number	26
Technical Support	26
<b>2 Introduction</b>	<b>29</b>

## Contents

Overview	29
Basic Principle	29
Optics System	29
Fluidics System	37
Electronics System	41
System Requirements	43
Software	43
Workstation	43
Fluidics Station	43
Compatible Sample Tubes	44
Instrument Reagents	44
QC Particles	44
System Components	44
NovoCyte Quanteon Instrument	45
NovoCyte Workstation and Monitor	46
NovoCyte Fluidics Station II	47
NovoCyte Fluidics Cart (Optional)	49
NovoSampler Q (Optional)	49
<b>3 Installation</b>	<b>51</b>
Installation Warnings	51
Space Requirements	52
Environmental Requirements	52
Instruction for Lifting and Carrying	52
Install NovoCyte Quanteon	53
Connect NovoCyte Workstation	54
Connect NovoCyte Fluidics Station II	54

## Contents

Connect NovoCyte Fluidics Cart (Optional)	55
Connect NovoSampler Q (Optional)	55
Connect Instrument to Power Supply	56
<b>4 Instrument Operation</b>	<b>57</b>
Instrument Start-up	57
Pre-Inspection	57
Power on the Instrument	57
Turn on Workstation	58
Add Instrument Reagents	59
Empty Waste	60
Verify and Modify Instrument Configuration	61
View and Verify Instrument Configuration	61
Modify Instrument Configuration	61
Instrument QC Test	68
Instrument Shutdown	68
<b>5 Running Samples</b>	<b>71</b>
Overview	71
Create Experiment	72
Define Sample Acquisition Parameters	74
Set Sample Acquisition Conditions	76
Stop Condition	76
Flow Rate	77
Threshold	77
Run Sample	80
Perform Fluorescence Compensation	82
Automatic Fluorescence Compensation	82

## Contents

Manual Fluorescence Compensation	92
Analyze Data	97
Append Data	101
Delete Data	102
Save Data	102
Import and Export Files	103
<b>6 System Maintenance</b>	<b>107</b>
Scheduled Maintenance	107
Preventative Maintenance	108
Replacing Fluidic System Consumables	113
Replace 0.05 µm Sheath Fluid Ultrafiltration (UF) Filter (Optional)	122
Unscheduled Maintenance	125
Debubble	125
Clean the External Surface of the Instrument	126
Decontamination	126
Prime Fluidic System before Long-Term Storage	127
Prime Fluidic System after Long-Term Storage	128
Purge Fluidic System before Shipment	128
Calibrate NovoCyte Fluidics Station II	130
Clean the Optical Filters	131
Clean Fluidic System	132
<b>7 Troubleshooting</b>	<b>133</b>
<b>8 Version History</b>	<b>137</b>
<b>Appendix A: NovoCyte Quanteon Laser and Detection Channel Configuration</b>	<b>139</b>
Laser Configuration	139



## Contents

Detection Channel Configuration	139
<b>Appendix B: NovoCyte Quanteon Technical Specifications</b>	<b>143</b>
NovoCyte Quanteon Technical Specifications	143
NovoCyte Workstation and Monitor Specifications	146
NovoCyte Fluidics Station II Specifications	146

## Contents

This page is intentionally left blank.

# 1

## Prologue

This chapter describes the purpose and scope of this guide, symbols used in this guide, glossary, safety and limitations, Agilent regulatory compliance statement and technical support information.

### Using this Guide



This guide describes the information and procedures to install, operate, maintain, and troubleshoot NovoCyte Quanteon flow cytometer and associated standard accessories.

For additional information about NovoExpress software, please refer to [NovoExpress Software Guide](#). For additional information about NovoSampler Q, please refer to [NovoSampler Q Operator's Guide](#). For additional information about NovoCyte Fluidics Cart, please refer to [NovoCyte Fluidics Cart Operator's Guide](#).

### Symbols



The following table lists the symbols which may be used in this guide.

**Table 1** Symbols used in this guide

Symbol	Meaning	Description
	BIOHAZARD	This symbol indicates that certain precautions must be taken when working with potentially infectious biological specimens and materials.
	LASER RADIATION	This symbol indicates that the operation could potentially cause exposure to laser radiation. Protective measures should be taken during the operation.







## Prologue

**Table 1 Symbols used in this guide**

	WARNING	This symbol indicates that improper or unsafe operation could result in instrument damage, data loss, and personal injury.
	SHOCK HAZARD	This symbol indicates that the operation has a risk of electric shock.

The following table lists the symbols which may appear on the instrument:

**Table 2 Symbols appear on the instrument**

Symbol	Meaning	Description
	KC Marking	This symbol indicates compliance with Korea EMC regulation requirements for Broadcasting and Communication Equipment.
	RCM Marking	This symbol indicates compliance with EMC regulations in Australia and New Zealand.
	CE marking	This symbol indicates conformity with the provisions of relevant directives for CE marking.
	SGS marking	This symbol indicates SGS has evaluated the safety of this product to comply with the provisions of relevant standards for US and Canada.
	WEEE Symbol	This symbol indicates conformity with Directive 2012/19/EU on Waste Electrical and Electronic Equipment (WEEE).
	Environment Friendly Use Period (EFUP)-China RoHS label	This symbol indicates the product contains certain hazardous substances and can be used safely during its environmental protection use period (40 years) which should enter into the recycling system after 40 years.
CAN ICES-1/NMB-1	Canadian EMC Regulation	This symbol indicates the product conforms to following standards: <ul style="list-style-type: none"> <li>• CISPR 11/EN 55011: Group 1, Class A</li> <li>• IEC/EN 61326-1</li> </ul> This ISM device complies with Canadian ICES-001
ISM 1-A	ISM Class A Group 1 Product Statement	This symbol indicates the product conforms to following standards:





## Prologue

**Table 2 Symbols appear on the instrument**

	<ul style="list-style-type: none"><li>• Group 1 ISM equipment: Group 1 contains all ISM equipment in which there is internationally generated and/or used conductively coupled radio-frequency energy which is necessary for the internal functioning of the equipment itself.</li><li>• Class A Equipment: equipment suitable for use in all establishments other than domestic and those directly connected to a low voltage power supply network which supplies buildings used for domestic purposes.</li></ul> <p>This product complies with the requirement of CISPR 11, Group 1, Class A as radiation professional equipment. Therefore, there may be potential difficulties in ensuring electromagnetic compatibility in other environments, due to conducted as well as radiated disturbances.</p>
COM	COM communication port
USB	USB communication port
NET	Network communication port



The following precaution labels appear on Agilent flow cytometer and associated accessories to indicate a potential hazard. Please do not remove these labels. Use appropriate precaution to avoid injury by the indicated hazard. Please refer to [Safety and Limitations](#) in this guide for more information.

**Table 3 Precaution labels appear on Agilent Flow Cytometer and Accessories**

Symbol	Meaning	Description
	BIOHAZARD	This symbol indicates that certain precautions must be taken when working with potentially infectious biological specimens and materials.
	SHOCK HAZARD	This symbol indicates that the operation has a risk of electric shock.
	LASER RADIATION	This symbol indicates that the operation could potentially cause exposure to laser radiation. Protective measures should be taken during the operation.
	MOVING PARTS	This label indicates the moving parts in the instrument. Be careful during the operation.

## Prologue

**Table 3** Precaution labels appear on Agilent Flow Cytometer and Accessories

	<p>CLASS I LASER PRODUCT</p>	<p>This symbol indicates the laser is a Class I product (see <a href="#">Laser Product Classification</a> in this guide for more information.)</p>
	<p>PINCH HAZARD</p>	<p>This symbol indicates the part may cause potential pinch hazard. Keep hands and fingers away from the part.</p>
	<p>WARRANTY VOID</p>	<p>This symbol indicates that the user is not allowed to remove or disassemble the parts. Doing so will void the warranty on the product.</p>

## Glossary

The following table lists the glossary which may appear in this guide.

**Table 4** Glossary used in this guide

Term	Definition
ADC	Analog-to-Digital Converter
Alexa Fluor	Alexa Fluor Dye
AmCyan	AmCyan Fluorescent Protein Dye
APC	Allophycocyanin Dye
APC-Cy7	APC and Cyanine 7 Tandem Dye
APD	Avalanche Photodiode
BP	Band Pass
BUV	Brilliant Ultraviolet
BV	Brilliant Violet
BXXX	488 nm (blue) laser excited fluorescence channels or photodetectors. For example, B572 denotes the 572/28 channel excited by the 488 nm laser, and so on.
CSV	Comma-Separated Values

## Prologue

**Table 4** Glossary used in this guide

CV	Coefficient of Variation
EYFP	Enhanced Yellow Fluorescent Protein Dye
FCS	Flow Cytometry Standard
FITC	Fluorescein Isothiocyanate Dye
FPGA	Field Programmable Gate Array
FRM	Full Reflection Mirror
FSC	Forward Scatter, Forward Scattered Light
HPCV	Half-Peak Coefficient of Variation
LP	Long Pass
MESF	Molecules of Equivalent Soluble Fluorochrome
MFI	Mean Fluorescence Intensity
Pacific Blue	Pacific Blue Dye
Pacific Orange	Pacific Orange Dye
PD	Photodiode
PE	Phycoerythrin Dye
PE-Alexa Fluor	Phycoerythrin and Alexa Fluor Tandem Dye
PE-Cy5	Phycoerythrin and Cyanine 5 Tandem Dye
PE-Cy5.5	Phycoerythrin and Cyanine 5.5 Tandem Dye
PE-Cy7	Phycoerythrin and Cyanine 7 Tandem Dye
PerCP	Peridinin Chlorophyll Protein Dye
PerCP-Cy5.5	Peridinin Chlorophyll Protein and Cyanine 5.5 Tandem Dye
PerCP-eFluor	Peridinin Chlorophyll Protein and eFluor Tandem Dye
PE-Texas Red	Phycoerythrin-Texas Red Dye
PI	Propidium Iodide Dye
PMT	Photomultiplier Tube
Qdot	Qdot Dye
RXXX	637 nm or 640 nm (red) laser excited fluorescence channels or photodetectors. For example, R695 denotes the 695/40 channel excited by the 637 nm or 640 nm laser, and so on.
SD	Standard Deviation
SIP	Sample Injection Probe

## Prologue

**Table 4** Glossary used in this guide

SiPM	Silicon Photo Multiplier
SP	Short Pass
SSC	Side Scatter
TEC	Thermoelectric Cooling
UVXXX	349 nm (ultraviolet) laser excited fluorescence channels or photodetectors. For example, UV615 denotes the 615/20 channel excited by the 349 nm laser, and so on.
VXXX	405 nm (violet) laser excited fluorescence channels or photodetectors. For example, V445 denotes the 445/45 channel excited by the 405 nm laser, and so on.
YXXX	561 nm (yellow) laser excited fluorescence channels or photodetectors. For example, Y586 denotes the 586/20 channel excited by the 561 nm laser, and so on.

Cy is a trademark of GE Healthcare/Amersham Biosciences.

Brilliant Violet is a trademark of Sirigen Group, Ltd.

Pacific Blue and Pacific Orange are trademarks of Life Technologies Corporation.

Alexa Fluor and Texas Red are registered trademarks of Life Technologies Corporation.

Qdot is a registered trademark of Quantum Dot Corporation.

eFluor is a registered trademark of eBioscience, Inc.

BD Horizon Brilliant Ultraviolet (BUV) is a trademark of Becton, Dickinson and Company or its affiliates.

PerCP: US patent 4,876,190

APC-Cy7: US patent 5,714,386

PE-Cy7: US patent 4,542,104

## Safety and Limitations

Agilent flow cytometers and associated accessories are limited to be operated by professionals trained by Agilent Technologies or an authorized representative. Agilent flow cytometer incorporates safety measures to protect the operator. Please refer to this guide to operate the instrument in strict accordance with the instructions and in accordance with the provisions of instrument maintenance and repair. Please ensure that the safety information can be found at any time. The



## Prologue

instrument may be damaged if it is operated under any conditions that are not described in this guide.

### General Safety

The following general safety precautions must be observed during all phases of operation of Agilent flow cytometer and associated accessories. Failure to comply with these precautions or with specific warnings or operation instructions in the operator's guide violates safety standards of design, manufacture, and intended use of the instrument. Agilent Technologies assumes no liability for the customer's failure to comply with these requirements.

#### CAUTION

**Do not use this product in any manner not specified by the manufacturer. The protective features of this product may be impaired if it is used in a manner not specified in the operation instructions.**

---

#### WARNING



**Before applying power, verify that all safety precautions are taken according to the operator's guide of the individual instrument. Verify that the voltage range and frequency of your power distribution matches to the power specification of the individual instrument. Never use cables other than the ones supplied by Agilent Technologies to ensure proper functionality and compliance with safety or EMC regulations. Make all connections to the unit before applying power. Note the instrument's external markings are described in [Table 3](#) of this guide.**

---

#### WARNING



**If your product is provided with a grounding type power plug, the instrument chassis and cover must be connected to an electrical ground to minimize shock hazard. The ground pin must be firmly connected to an electrical ground (safety ground) terminal at the power outlet. Any interruption of the protective (grounding) conductor or disconnection of the protective earth terminal will cause a potential shock hazard that could result in personal injury. Please refer to [Electrical Safety](#) of this guide for additional information.**

---

## Prologue

**WARNING** Do not operate the instrument in the presence of flammable gases or fumes.

---

**WARNING** Do not remove the instrument cover. Only Agilent authorized personnel are allowed to remove instrument covers. Always disconnect the power cables and any external circuits before removing the instrument cover.

---

**WARNING** Do not modify the instrument. Do not install substitute parts or perform any unauthorized modification to the product. Return the product to an Agilent Sales and Service Office for service and repair to ensure that safety features are maintained.

---

**WARNING** Instruments that appear damaged or defective should be made inoperative and secured against unintended operation until they can be repaired by qualified service personnel.

---

**WARNING** The handling of toxic and hazardous solvents and flammable liquids can hold health risks. When working with solvents, ensure to observe appropriate safety procedures (for example, goggles, safety gloves and protective clothing) as described in the material safety data sheet supplied by the solvent vendor, especially when toxic or hazardous solvents and flammable liquids are used. Do not use solvents with an auto-ignition temperature below 200°C.

---

**WARNING** When operating the instrument, keep your hands and clothing away from the instrument. Do not touch the sample injection probe (SIP) when the instrument is in operation. Mechanical movable parts within the instrument can pinch or cause injury to hands or fingers.

---

**WARNING** To avoid burns, do not touch the fan guards on the back of the instrument. The fan guards may get hot during and after instrument operation.

---

## Prologue

### CAUTION

The data is automatically stored on the workstation's hard drive. But if the workstation hard drive data are deleted or the hard drive is corrupted, the data can be unrecoverable. Please regularly backup the data to a server or other mobile storage devices.

---

### WARNING

To prevent accidents and to ensure the quality of the data after Agilent Technologies professionals install the instrument, moving the instrument is not recommended. If you need to move the instrument, be sure to contact Agilent Technologies professionals. Agilent Technologies professionals will re-install the instrument in accordance with requirements and ensure the optimal operation of the instrument.

---

### WARNING

The sample injection probe is a mechanical movable part and may pinch or injure your fingers. To prevent accidents, do not put your hand underneath the sample injection probe during the sample acquisition process. Also, when placing or removing the sample tube, do not put your hand underneath the sample injection probe.

---

### CAUTION

Do not place any heavy objects on top of the instrument. Doing so may cause damage to the instrument, resulting in compromised instrument performance and abnormal data.

---

### WARNING

Regarding the restrictions on the use of reagents, please see the relevant package insert and technical data sheet of the reagents.

---

## Ergonomics

This product is large and the weight is more than 51 lb (23 kg).

### WARNING

To avoid injury to personnel and potential equipment damage, use sufficient assistance and proper lifting techniques when moving or lifting the product.

---

## Prologue

### Electrical Safety

#### **WARNING**



To prevent electrical shock and instrument damage, please follow the guidelines listed below.

- Unless otherwise specified, turn off the power switch and unplug the power cord before servicing the instrument.
- Connect the instrument only to an approved power source. If damaged electrical wires, plugs, or cables are detected, promptly contact your Agilent Technologies representative for replacement.
- Only use the power outlets that are located at a conveniently accessible location so that the instrument, workstation, and monitor can be easily plugged to and unplugged from the power outlets.
- To ensure your safety, the power cord must be inserted in the three-pin socket with a protective ground connection. Please make sure the three-pin socket connects to the ground reliably.
- If leaks are detected, immediately turn off the power by pressing and holding the power button on the front of the instrument for about 6-7 seconds. Immediately contact your local Agilent Technologies representative for support.
- If the power cord becomes frayed, broken, or damaged, please contact Agilent Technologies. Do not replace with a lower rated cord. If the equipment is been used in a manner which is not specified by Agilent Technologies, the protection provide by the equipment may be impaired.

### Laser Safety

Laser or laser systems emit intense, coherent electromagnetic radiation that has the potential of causing irreparable damage to human skin and eyes. The main hazard of laser radiation is direct or indirect exposure of the eye to thermal radiation from the visible and near infrared region (325 - 1400 nm). Direct eye contact with the laser will burn the cornea, retina, or both injury and may lead to possible blindness.

There are other potentially serious hazards in other spectral regions. Excessive ultraviolet exposure produces an intolerance to light (photophobia) accompanied by redness, a tearing discharge from the mucous membrane lining the inner surface of the eyelid (conjunctiva), shedding of the corneal cell layer surface (exfoliation), and stromal haze. These symptoms are associated with

## Prologue

photokeratitis, otherwise known as snow blindness or welder's flash, which results from radiant energy–induced damage to the outer epidermal cell layer of the cornea. These effects can be the result of laser exposure lasting only a fraction of a second.

### Laser Product Classification

Laser hazard levels depend on the wavelength used and the energy content. A numbered system is used to categorize lasers according to different hazard levels. The higher the classification number, the greater the potential hazard is. Agilent flow cytometer is a Class I laser product according to IEC/EN 60825-1:2014. The lasers and the laser energy are fully contained within the instrument structure and do not require a special work area except during service procedures. These service procedures, including laser maintenance and repair, can only be carried out by qualified Agilent service professionals.

#### **WARNING**



**In order to avoid the risk of exposure to laser light, be sure to follow the guidelines listed below.**

- Modification or removal of the optical covers or laser shielding could result in exposure to hazardous laser radiation. To prevent irreparable damage to human skin and eyes, do not remove the optics covers or laser shielding, adjust controls, or attempt to service the instrument at areas where laser hazard warning signs are attached.
- Operating the instrument under conditions other than those specified in this guide may result in hazardous radiation exposure.
- Keep all doors and covers closed during operation of the instrument. When operated under these conditions, the instrument poses no danger of exposure to hazardous laser radiation.

### Biosafety

#### **WARNING**



**All biological specimens and materials in contact with biological specimens are potentially biohazardous. In order to avoid exposure to biohazardous material, be sure to follow the guidelines listed below.**

## Prologue

- Treat and handle all biological specimens and materials as if they are capable of transmitting infection. Dispose of waste using proper precautions and in accordance with local regulations. Never pipette by mouth.
- Avoid directly touching the biological specimens and waste. Wear suitable protective clothing, eyewear, and gloves when handling biological specimens and materials. If the biological samples accidentally contact with the skin, follow proper work safety procedures and immediately consult a medical professional.
- Gloves must be worn when manually loading the sample to the sample holder on the instrument.
- Reagents, including the sheath fluid, cleaning solution, and rinsing solution, may cause damage to the skin. Be cautious around sheath fluid, cleaning solution, and rinsing solution, and prevent direct contact with hands and clothes. If there has been accidental contact with hands or clothing, immediately rinse with soap and tap water. If it gets into eyes, immediately rinse with plenty of water and consult a medical professional.
- Sheath fluid, cleaning solution, rinsing solution, and waste may contain materials controlled by contamination regulations and emission standards. Please follow local regulations and guidelines for proper disposal.
- Dispose of waste in accordance with local regulations. Use proper precaution and wear suitable protective clothing, eyewear, and gloves when disposing of waste.
- Prevent waste overflow by emptying the waste container frequently or whenever the system gives Waste is Full warning.
- Be sure to place the second sample tube only after the rinsing procedure is fully completed for the previous sample. Otherwise, there is possibility that the content from the previous sample may contaminate or dilute the second sample, or even cause the second sample to overflow which may lead to exposure to biohazardous material.

## Limitations

Agilent Technologies provides NovoExpress software and NovoCyte Workstation that are intended for running Agilent flow cytometer. Buyers/users are responsible to ensure that all software, transmitted media, and electronic documents are virus free. If the workstation is used with a network connection, buyers/users are responsible for installation and maintenance of up-to-date virus protection software. Agilent Technologies does not provide warranty with respect to the workstation remaining virus free after installation. Agilent Technologies is not

## Prologue

liable for any claims related to or resulting from buyer/user's failure to install and maintain virus protection.

**WARNING** Do not use the instrument, workstation, and other parts supplied by Agilent Technologies in an oxygen-enriched atmosphere.

---

**WARNING** Do not use the instrument, workstation, and other parts supplied by Agilent Technologies with flammable liquid/explosive gas or reagents.

---

**WARNING** Do not use the expired consumables and reagents.

---

## Agilent Regulatory Compliance Statement

### CE Compliance

Your Agilent instrument has been designed to comply with the requirements of the applicable directives of the European Union, such as Electromagnetic Compatibility (EMC) Directive, Low Voltage Directive (LVD), Machinery Directive (MD), RoHS Directive, etc. Agilent has confirmed that each product complies with the relevant Directives by testing samples against the harmonized EN (European Norm) standards published on the Official Journal of the European Union (OJEU).

Proof that a product complies with these directives is indicated by:

- the CE Marking appearing on the rear of the product, and
- the documentation package that accompanies the product containing a copy of the Declaration of Conformity. The Declaration of Conformity is the legal declaration by Agilent that the product complies with the relevant directives listed above, and shows the EN standards to which the product was tested to demonstrate compliance.

### Electromagnetic Compatibility

This product conforms to the following regulations on Electromagnetic Compatibility (EMC) and Radio Frequency Interference (RFI):

## Prologue

- CISPR 11/EN 55011: Group 1, Class A
- IEC/EN 61326-1
- AUS/NZ 
- Canada ICES-001 (This ISM device complies with Canadian ICES-001. Cet appareil ISM est conforme à la norme NMB-001 du Canada).

**Group 1 ISM equipment:** group 1 contains all Industrial, Scientific and Medical (ISM) equipment in which there is intentionally generated and/or used conductively coupled radio- frequency energy which is necessary for the internal functioning of the equipment itself.

**Class A equipment** is equipment suitable for use in all establishments other than domestic and those directly connected to a low voltage power supply network which supplies buildings used for domestic purposes.

This device complies with the requirements of CISPR11, Group 1, Class A as radiation professional equipment. Therefore, there may be potential difficulties in ensuring electromagnetic compatibility in other environments, due to conducted as well as radiated disturbances.

If this equipment does cause harmful interference to radio or television reception, which can be determined by turning the equipment off and on, the user is encouraged to try one or more of the following measures:

- 1 Relocate the radio or antenna.
- 2 Move the device away from the radio or television.
- 3 Plug the device into a different electrical outlet, so that the device and the radio or television are on separate electrical circuits.
- 4 Make sure that all peripheral devices are also certified.
- 5 Make sure that appropriate cables are used to connect the device to peripheral equipment.
- 6 Consult your equipment dealer, Agilent Technologies, or an experienced technician for assistance.

Changes or modifications not expressly approved by Agilent Technologies could void the user's authority to operate the equipment.

**Class B equipment** is equipment suitable for use in domestic establishments and in establishments directly connected to a low voltage power supply network which supplies buildings used for domestic purposes.



## Prologue

### EMC Declaration for South Korea

#### 사용자안내문

This equipment has been evaluated for its suitability for use in a commercial environment. When used in a domestic environment, there is a risk of radio interference.

이 기기는 업무용 환경에서 사용할 목적으로 적합성평가를 받은 기기로서 가정용 환경에서 사용하는 경우 전파간섭의 우려가 있습니다.

※ 사용자 안내문은 " 업무용 방송통신기자재 " 에만 적용한다.

### Detachable Power Cord Declaration for Japan

#### 電源コードセットの取扱いについて（日本国内向け）

製品には、同梱された電源コードセットをお使いください。同梱された電源コードセットは、他の製品では使用できません。

Notice - The power cords for Japanese market

Your product must only use the power cord that was shipped with this product. Do not use this power cord with any other product.

### Sound Emission Certification for Federal Republic of Germany

#### Sound pressure

Sound pressure  $L_p < 60$  dB(A) according to DIN EN ISO 7779.

#### Schalldruckpegel

Schalldruckpegel  $LP < 60$  dB(A) nach DIN EN ISO 7779.

### Waste Electrical and Electronic Equipment (WEEE) Directive

This product complies with the European WEEE Directive marking requirements. The affixed label indicates that you must not discard this electrical/electronic product in domestic household waste.



## Prologue

### NOTE

Do not dispose of in domestic household waste.

To return unwanted products, contact your local Agilent office, or see <https://www.agilent.com> for more information.

### Regulatory Compliance Identification Number

For the purpose of regulatory compliance certifications and identification, your product may have been assigned a unique **Agilent Regulatory Model Number (RMN)**. This RMN can be found on the product nameplate label, along with all required approval markings and information. When requesting compliance information for this product, always refer to this RMN. The RMN should not be confused with the marketing name or model number of the product.

## Technical Support

If there are operating or technical questions, please refer to the sections relating to the instrument operation in this guide. If a problem occurs, refer to [Troubleshooting](#) in this guide for solutions. For additional technical support, please contact your local Agilent Technologies representative or distributor. When contacting Agilent Technologies, be sure to provide the following information:

- The product name, product model and serial number.
- Usage history of the instrument.
- Instrument status information on the status bar from the NovoExpress software. Or if there is a warning or error message, please also provide that information.
- Experiment information conducted on the instrument, if not confidential.
- Details of recent instrument QC test.

For support within the US, please call 800-227-9770.

For support within China, please call 800-820-3278 (Desk) or 400-820-3278 (Cell).

For users in other countries or regions, contact your local Agilent Technologies representatives or distributors, which may be found at <https://www.agilent.com>.

## Prologue

### NOTE

When encountering an issue during operation of Agilent flow cytometer and associated accessories, it is highly recommended to submit a Technical Support Request by clicking **Home > Technical Support Request** in the NovoExpress main window. The **Technical Support Request Creation Wizard** automatically collects the instrument configurations, system logs, current screenshot, current experiment file and other information that helps in the diagnosis and troubleshooting of Agilent flow cytometer. User can also attach any other files using this function. Please refer to [NovoExpress Software Guide](#) for detailed information on this function.

---

## Prologue

This page is intentionally left blank.

## 2 Introduction

This chapter provides overview of NovoCyte Quanteon flow cytometer, including basic instrument operation principle, system requirements, and system components.

### Overview

Agilent flow cytometer can be used for scientific research, including but not limited to detection and analysis of cell surface antigens, intracellular activity analysis, detection and analysis of apoptosis, DNA content detection, cell cycle analysis of the nucleus, analysis of cell proliferation, and GFP reporter gene detection, etc.

Agilent flow cytometer can detect a particle with the size of 0.1  $\mu\text{m}$  - 50  $\mu\text{m}$ . Besides human cells, it can also be used to analyze:

- Animal Cells
- Plant Cells
- Marine plankton
- Bacteria
- Fluorescent microspheres

### Basic Principle

Agilent flow cytometer contains the optics system, the fluidics system, and the electronics system. This section describes the basic principle of these subsystems and their components.

#### Optics System

The optics system consists of lasers, optical lenses, beam shaping optics, light collection optics, optical filters, and photodetectors. Lasers illuminate the cells or

## Introduction

particles in the sample. Optical lenses shape the laser beam into a spot with appropriate shape and size. Optical lenses are also used to collect the light emitted from the cells or particles when they pass through the laser beam. Optical filters direct the light collected by the optical lenses to the appropriate detectors. When the stained cells or other particles pass through the focused laser beam, scattered light and fluorescence signals will be generated. Such light is collected by the light collecting optics and converted by the photodetectors into electronic signals.

### Lasers

Agilent flow cytometer uses low-power solid-state lasers to provide reliable and high-performance excitation sources for the instrument. Solid-state lasers have compact size, excellent performance, good stability, long lifetime, and other advantages. The lasers come with a thermoelectric cooling (TEC) system to ensure its extraordinary beam quality. Agilent flow cytometer offers up to five lasers to meet the needs for different applications. Customized model other than the standard configuration is available. Please refer to [Appendix A](#) in this guide for more details of your product. Please contact Agilent local sales representatives or distributors for customized model request.

### Beam Shaping Optics

Beam shaping optics shape the laser beam into an elliptical spot and focus the spot at the center of the flow cell.

### Light Collection Optics

The light collection optics efficiently collect the light emitted by the particles or cells from the center of the flow cell, including forward scatter light, side scatter light and fluorescence signals.

### Optical Filters

Optical filters regulate the spectral distribution of light scatter and fluorescence directed to the photodetectors. When photons encounter an optical filter, they are transmitted, absorbed, or reflected. In general, optical filters can be divided into longpass filters, shortpass filters, and bandpass filters.

In Agilent flow cytometer, longpass and shortpass filters (also called dichroic mirrors) allow part of the light to be transmitted and part of the light is reflected. Incident light typically enters the filter at an angle of  $45^\circ$ . The transmitted light travels in the same direction as the incident light ( $\lambda_2$ ), whereas the reflected light is reflected in a  $90^\circ$  angle relative to the incident light ( $\lambda_1$ ) (Figure 1).

## Introduction

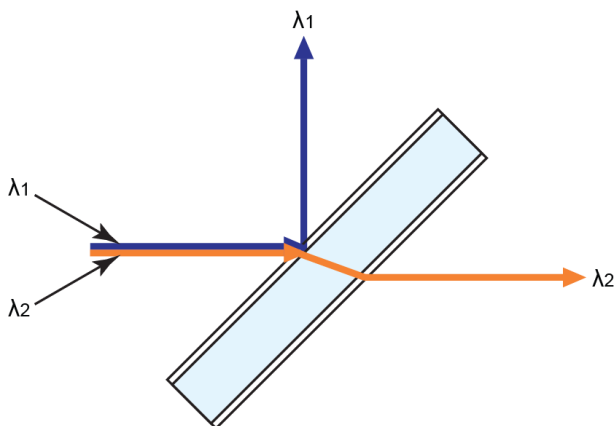

**Figure 1.** Longpass Filter and Shortpass Filter

The bandpass filters are usually placed at a 90° angle relative to the incident light and regulate the incident light. The transmitted light travels in the same direction as the incident light ( $\lambda_2$ ), whereas the reflected light is reflected in a 180° angle relative to the incident light ( $\lambda_1$  and  $\lambda_3$ ) (Figure 2).

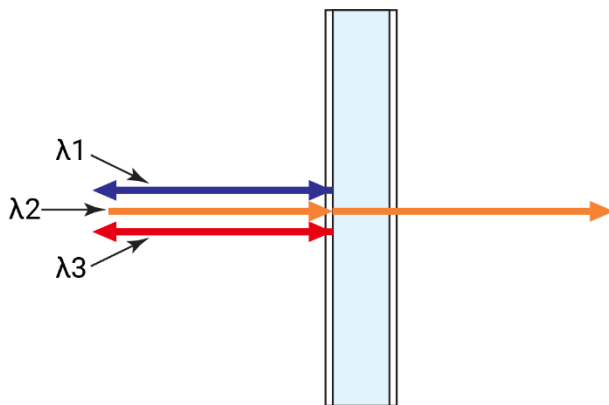

**Figure 2.** Bandpass Filter

### NOTE

Refer to [Appendix A](#) in this guide for list of the optical filters used for your product.

- Longpass Filters

Longpass (LP) filters pass wavelength longer than the cutoff wavelength. For example, a 505 nm LP filter allows wavelengths longer than 505 nm to pass through it and either absorbs or reflects wavelengths shorter than 505 nm as shown in Figure 3.

## Introduction

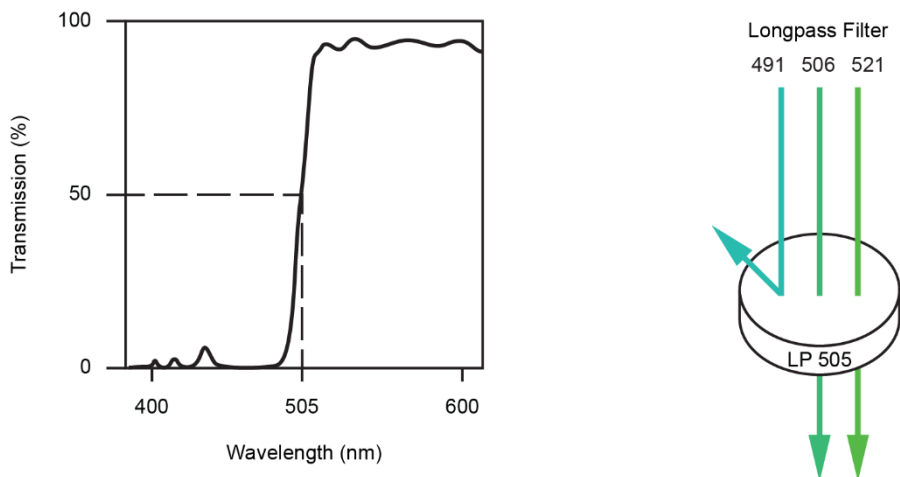

**Figure 3.** 505 nm Longpass Filter

- Shortpass Filters

Shortpass filters (SP) pass light with a shorter wavelength than the cutoff wavelength. For example, a 472 nm shortpass filter allows wavelengths shorter than 472 nm to pass through it and either absorbs or reflects wavelengths longer than 472 nm as shown in Figure 4.

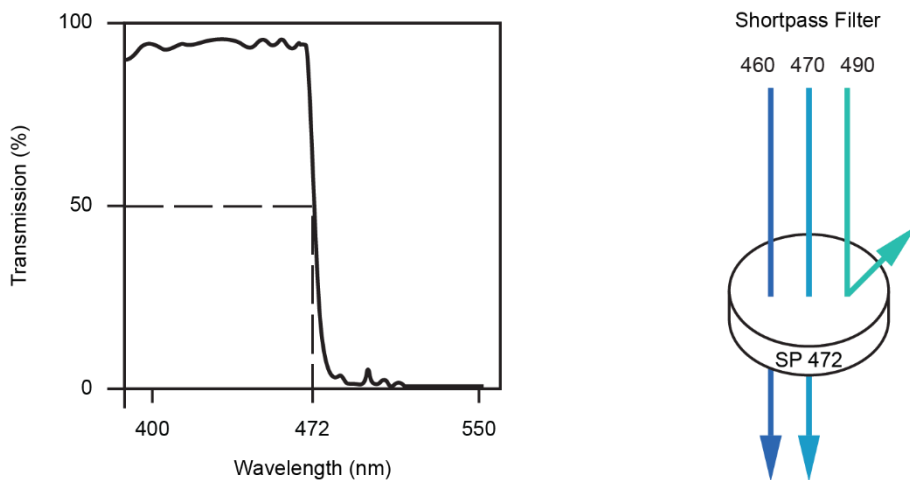

**Figure 4.** 472 nm Shortpass Filter

- Bandpass filters



## Introduction

A bandpass (BP) filter transmits a relatively narrow range or band of light. Bandpass filters are typically designated by two numbers. The first number indicates the center wavelength and the second number refers to the range of the light wavelength that is passed through. For example, a 572/28 BP filter transmits light that is centered at 572 nm and has a total bandwidth of 28 nm. Therefore, this filter transmits light between 558 nm and 586 nm as shown in Figure 5.

A bandpass filter is used in front of each photodetector to only allow the light in a particular range to be detected by the detector. Commonly, the name of the bandpass filter is used interchangeably with fluorescence channel to specify the detection wavelength range. For example, PE is routinely detected by a 572/28 bandpass filter. Therefore, 572/28 is referred as a PE fluorescence detection channel.

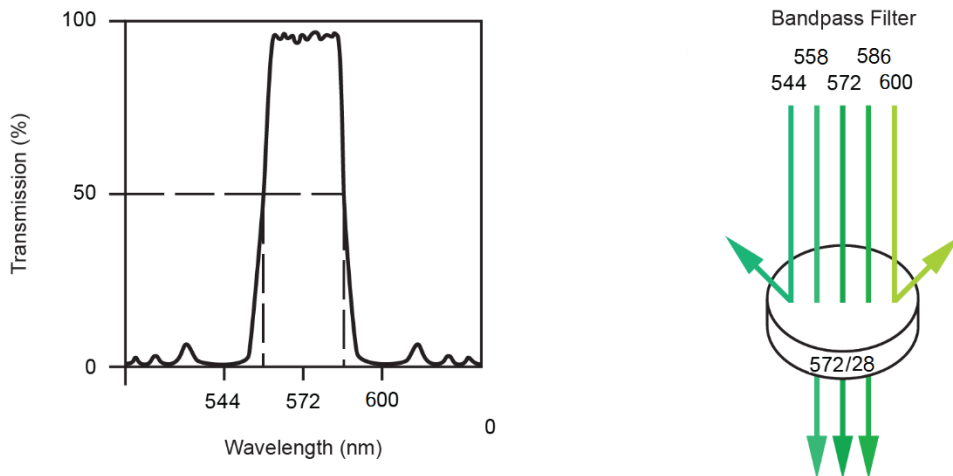

**Figure 5.** 572/28 nm Bandpass Filter

## Photodetectors

Photodetectors convert the light signal into an electrical signal.

## Light Scatter

When a cell or particle passes through a focused laser beam, light is scattered in all directions as shown in Figure 6. Light that scatters axial to the laser beam is called Forward Scatter (FSC). Light that scatters perpendicular to the laser beam is called Side Scatter (SSC). FSC and SSC are related to certain physical properties of cells:

- FSC - indicates relative size of the cells or particles

## Introduction

- SSC - indicates the internal complexity or granularity of the cells or particles

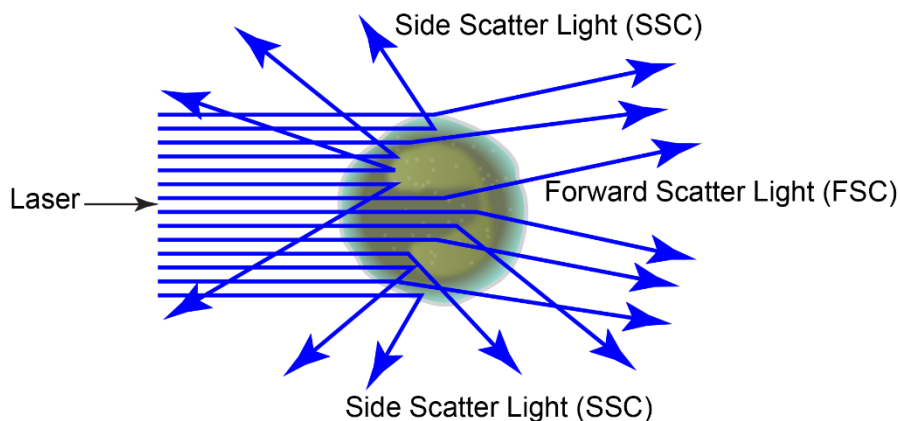

**Figure 6.** Forward Scatter (FSC) and Side Scatter (SSC)

## Fluorescence

When a cell or particle stained with fluorochrome-conjugated antibodies or other fluorescent labels passes through the focused laser beam, the fluorochrome or fluorescent labels (in general called dyes in this guide) can absorb photons (energy) and be excited to a higher energy state. This higher energy state is not stable so that the dyes will return to their ground state shortly, accompanied by the release of energy. Most energy is released in the form of emitted light, whereas a very small portion of the energy is released in the form of heat. The light emission is known as fluorescence.

Fluorescence is always a longer wavelength (lower-energy photon) compared to the excitation wavelength. The difference between the excitation maximum and the emission maximum is known as the Stokes shift. Some fluorochromes such as FITC have a smaller Stokes shift, absorbing blue light (488 nm) and emitting green light (525 nm), while other fluorochromes such as PerCP exhibit a larger Stokes shift, absorbing blue light (488 nm) and emitting red light (675 nm).

The emission spectra for some commonly used fluorochromes are shown in Figure 7.

## Introduction

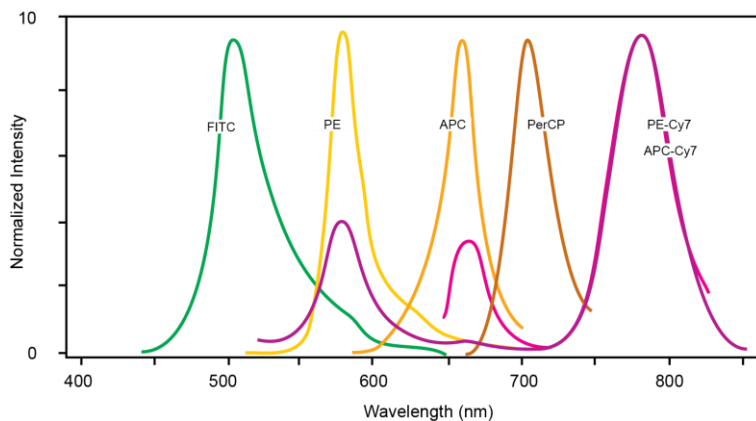

**Figure 7.** Emission Spectra of Commonly Used Fluorochromes

### Fluorescence Compensation Theory

Fluorochromes emit light over a range of wavelengths (Figure 7). Optical filters are used to limit the range of wavelength measured by a given detector. However, when two or more fluorochromes are used in the same test, the overlap in wavelength ranges often makes it impossible to isolate light from a given fluorochrome from another fluorochrome using optical filters. As a result, light emitted from one fluorochrome will appear in a detector intended for detecting the other fluorochrome (Figure 8). This is known as fluorescence spillover. Spillover can be corrected mathematically by using a method called compensation.

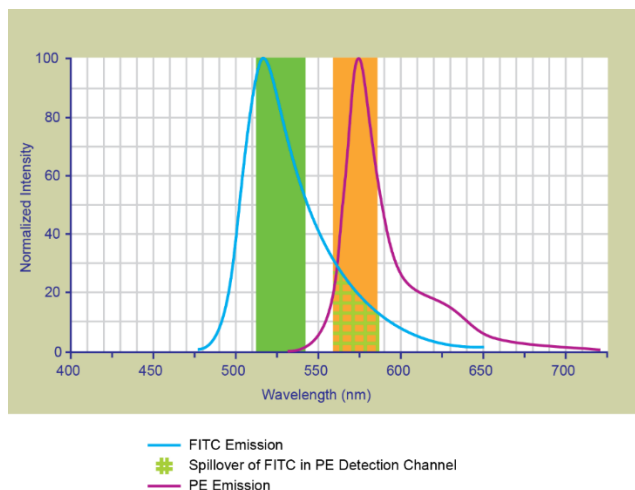

**Figure 8.** Spillover from the FITC Fluorochrome to the PE Detector

## Introduction

For example, Figure 8 shows FITC emission appears primarily in the FITC detector, but a small portion of its fluorescence spills over into the PE detector. The spillover is corrected by compensation, as indicated by the arrow in Figure 9. The purpose of the compensation is to move the FITC-positive population downwards until it has the same Mean or Median value of PE signal as the unstained population (Figure 10).

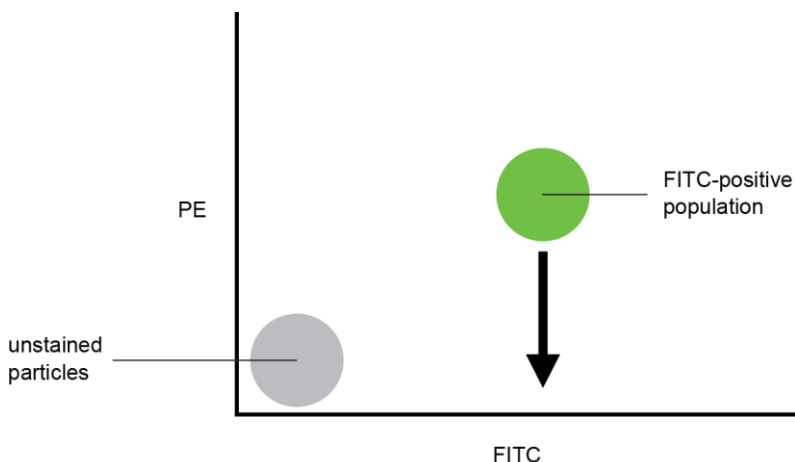

**Figure 9.** Theoretical Display of FITC vs. PE without Compensation

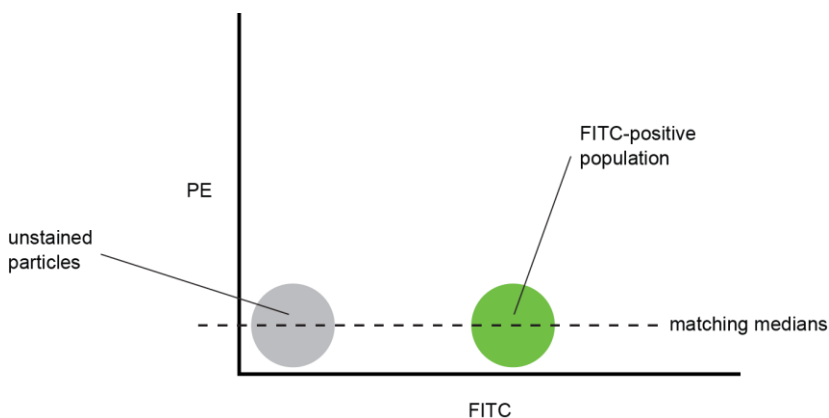
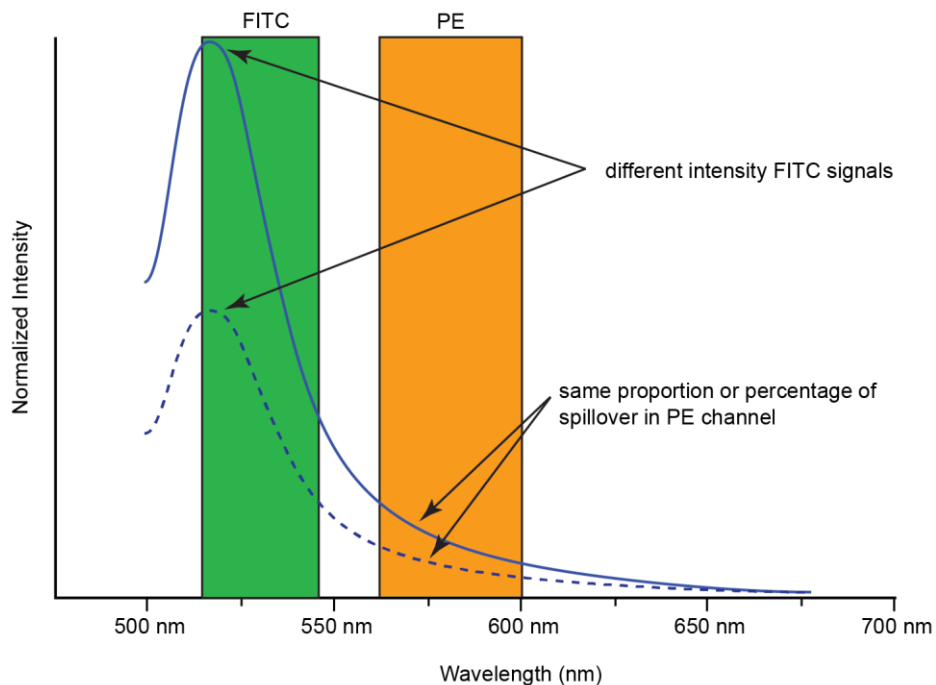

**Figure 10.** FITC Spillover Optimally Compensated out of the PE Signal

Once fluorescence compensation has been set using compensation control samples, such compensation settings remain valid for any subsequent sample, because compensation subtracts a percentage of the fluorescence signal, independent of the overall fluorescence intensity. Figure 11 illustrates this

## Introduction

principle. Although the signals differ in intensity, the percentage of the FITC spillover into the PE detector remains constant.



**Figure 11.** Spillover of Two FITC Signals of Different Intensities into PE Channels

The NovoExpress software provides flexible fluorescence compensation functions. Users can modify the compensation matrix manually or use the automatic compensation function. Fluorescence compensation can be conducted during or after sample acquisition.

### NOTE

For more information on how to conduct fluorescence compensation, please refer to [Perform Fluorescence Compensation](#) in this guide and [NovoExpress Software Guide](#) for details.

## Fluidics System

Agilent flow cytometer fluidics system consists of sample injection probe (SIP), SIP cleaning apparatus, driving pumps, flow cell, solenoid valves, and a series of tubings and connectors.

## Introduction

### Sample Injection Probe (SIP) and SIP Cleaning Apparatus

The sample injection probe, which is a hollow stainless-steel tube, is used to aspirate the sample from the test tube. When running samples, the sample injection probe will move downward from the housing into the test tube, draw a certain volume of the sample, and then retract back to the original position. By default, the SIP cleaning apparatus (Figure 12) will automatically clean the inner wall and the outer wall of the SIP after each sample acquisition. The waste fluid generated by SIP cleaning procedure is collected to the waste container. This automatic SIP cleaning function ensures minimal inter-sample carryover rate (<0.1%) and eliminates tedious manual cleaning processes.

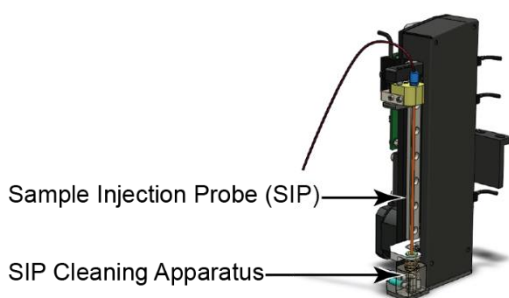

**Figure 12.** Sample Injection Probe (SIP) and SIP Cleaning Apparatus

#### NOTE

To increase the sampling speed, user can turn off the default automatic rinsing procedure that occurs after each sampling. To do so, uncheck the **Rinse after Sampling** box in the **Cytometer Control** panel from the NovoExpress software.

#### CAUTION

**The sample injection probe may perform multiple aspirations for one sampling. Do not remove or change the sample tube until the entire sampling process has completed.**

## Introduction

### WARNING

During sampling, do not obstruct the moving SIP. Do not place your hand on the test tube.

### WARNING



The sample injection probe directly contacts biological samples which may be biohazardous. Wear gloves when handling the sample injection probe.

### Driving pumps

A sheath pump is used to drive the sheath fluid at a constant flow rate (e.g. 6.5 mL/min). A high precision syringe pump is used to drive the sample.

### Flow Cell

When the sample flows into the flow cell, it will be hydrodynamically focused by the sheath fluid to align it with the interrogation point of the laser beam.

### Sampling Method and Sample Flow Rate Control

Agilent flow cytometer uses a high-precision syringe pump to aspirate the sample and drive it into the flow cell for analysis. This sampling method can precisely control the volume of the sample for accurate volumetric counting results.

During sampling, a certain volume of the sample set by the user in the NovoExpress software, plus an additional overhead volume, is first aspirated by the syringe pump from the sample tube through the sample injection probe. Then the syringe pump will push the aspirated sample into the flow cell to be analyzed. The sample is hydrodynamically focused by the sheath fluid to form a small stream inside the flow cell.

The diameter of the focused sample stream (called **Core Diameter**) is determined by the ratio between the sample flow rate and the sheath flow rate. When the sheath flow rate remains constant, the lower the sample flow rate, the smaller the core diameter, as illustrated in Figure 13.

## Introduction

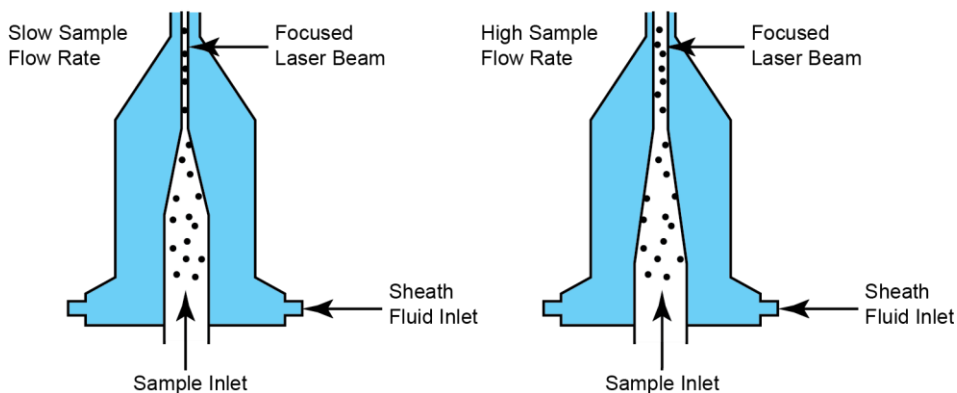

**Figure 13.** Hydrodynamic Focusing and Core Diameter under Different Sample Flow Rates

Having at most one cell or particle moving through a laser beam at a given time is critical for flow cytometry. This is achieved by the hydrodynamic focusing process. Proper operation of fluidic components is critical for particles to intercept the laser beam properly. Always ensure that the fluidics system is free of air bubbles, cell debris, and other contaminants. Choosing the appropriate sample flow rate for your experiment is important for obtaining good quality data.

- A higher sample flow rate is generally used for qualitative measurements such as immunophenotyping. The data is less resolved but is acquired more quickly.
- A lower flow rate is generally used in applications where greater resolution and quantitative measurements are critical, such as DNA content analysis.

There are three standard sample flow rate settings in Agilent flow cytometer, which is Slow (e.g. 14  $\mu\text{L}/\text{min}$ ), Medium (e.g. 35  $\mu\text{L}/\text{min}$ ) and Fast (e.g. 66  $\mu\text{L}/\text{min}$ ), corresponding to approximately 7.7  $\mu\text{m}$ , 12.2  $\mu\text{m}$  and 16.8  $\mu\text{m}$  core diameter respectively. The sample flow rate can also be continuously adjusted in NovoExpress software from 5  $\mu\text{L}/\text{min}$  to 120  $\mu\text{L}/\text{min}$ , which corresponds to a core diameter of 4.6  $\mu\text{m}$  to 22.7  $\mu\text{m}$ . The sheath flow rate is fixed at 6.5 mL/min.



## Introduction

### NOTE

To set the flow rate, please refer to [Set Sample Acquisition Conditions](#) in this guide and relevant sections in [NovoExpress Software Guide](#).

## Electronics System

### Pulse Generations

As cells or other particles pass through a focused laser beam, they scatter the laser light and can emit fluorescence. Because the laser beam is focused on a small spot and particles move rapidly through the flow cell, the scatter or fluorescence emission has a very brief duration, usually only a few microseconds. This brief emission of light is converted into an electrical signal (a pulse shown in Figure 14) by the photodetectors.

- 1 A pulse begins when a particle enters the laser beam. At this point, both the beam intensity and signal intensity are low.
- 2 The pulse reaches a maximum intensity or height when the particle reaches the middle of the beam, where the beam and signal intensity are the brightest. The peak intensity, or height of the pulse, is measured at this point.
- 3 As the particle leaves the beam, the pulse trails off below the threshold.

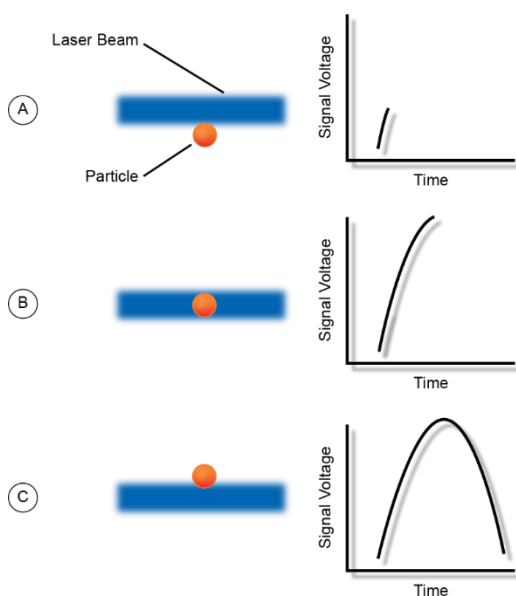
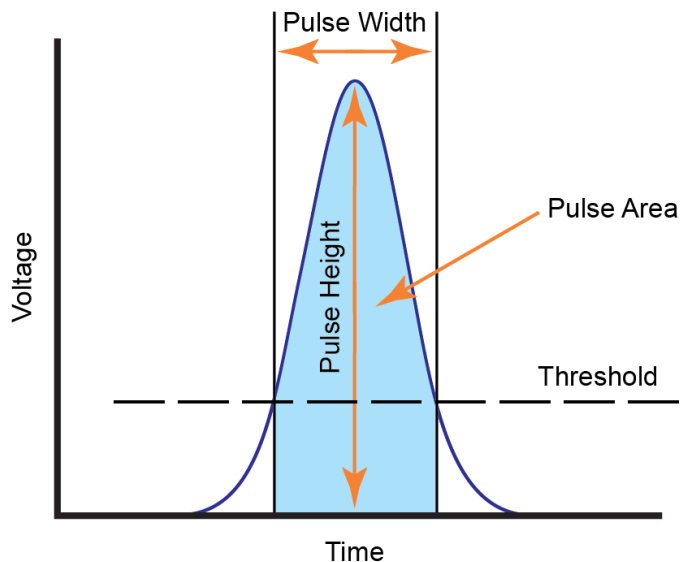

**Figure 14.** Illustration of Pulse Generation

## Introduction

### Pulse Measurements

The electronics system measures pulses by three characteristics: Height, Area, and Width, as shown in Figure 15.



**Figure 15.** Pulse Measurements

- Pulse Height is the maximum digitized intensity measured for the pulse.
- Pulse Area is an integration of the digitized measures of the pulse over time.
- Pulse Width is a time period within which the pulse measurement is above the threshold.

Electronics system calculates the Height and Area for FSC, SSC, and every selected fluorescence channel. Width is based on the FSC signal. One effective event has one Width parameter.

### Pulse Digitization

The electronics system digitizes the pulse produced by the photodetector. The digitized data is stored in memory and further processed to calculate the pulse Height, Area, and Width. A high-accuracy high-speed 24-bit analog-to-digital converter is used to process the pulse in a speed of 80 million times per second. Each pulse signal is divided into 16,777,216 ( $2^{24}$ ) levels (Figure 16). The Height, Area, and Width parameters of all available channels for each processed cell or particle are then transferred to the NovoCyte Workstation for further display and processing by the NovoExpress software.

## Introduction

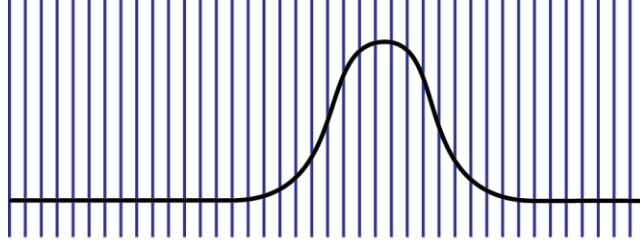

Signal Sampling Rate at 80M per second

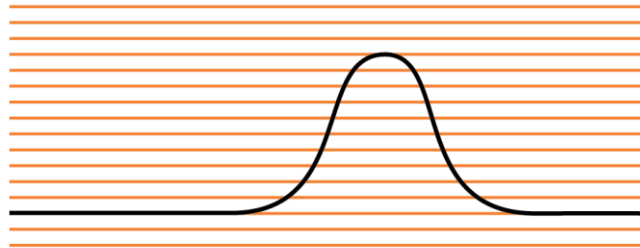

24 bits (16,777,216) Digitization

**Figure 16.** Pulse Digitization

## System Requirements

### Software

NovoExpress software.

### Workstation

NovoCyte Workstation.

### Fluidics Station

NovoCyte Fluidics Station II.

## Introduction

### Compatible Sample Tubes

NovoCyt<sup>e</sup> Quanteon flow cytometer can be equipped with two types of sample tube holder, one for 12 × 75 mm tubes (standard) and one for 1.5 mL or 2.0 mL tubes (optional), respectively.

### Instrument Reagents

- NovoFlow Sheath Fluid
- NovoClean Solution
- NovoRinse Solution

#### NOTE

Please consult the Agilent website or contact your local representative for more detailed ordering information.

### QC Particles

- Agilent Flow Cytometer QC Particles

#### NOTE

Please consult the Agilent website or contact your local representative for more detailed ordering information.

## System Components

NovoCyt<sup>e</sup> Quanteon flow cytometer includes the instrument, NovoCyt<sup>e</sup> Fluidics Station II and NovoCyt<sup>e</sup> Workstation by default (Figure 17).

## Introduction

### NOTE

NovoCyte Quanteon flow cytometer can also be connected to an optional NovoSampler Q for automatic collection of multiple samples, and an optional NovoCyte Fluidics Cart equipped with 15 L capacity of NovoFlow sheath fluid and waste containers. Please consult with Agilent sales representative for more details.

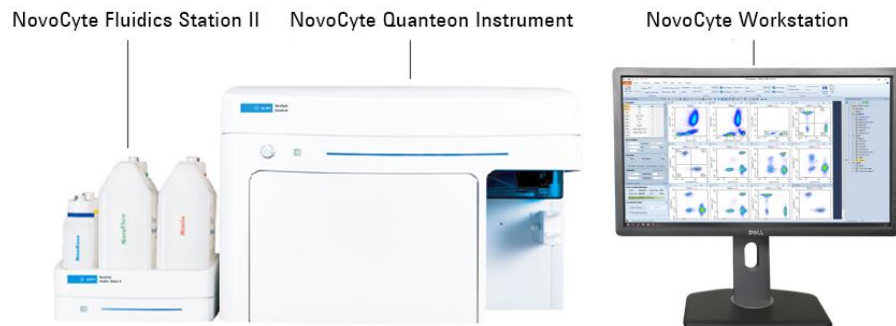

Figure 17. NovoCyte Quanteon Flow Cytometer

## NovoCyte Quanteon Instrument

The instrument front side (Figure 18) has a power switch, an LED status indicator, LED light, and a front panel cover. By default, a single tube holder is pre-installed on the right side of the front panel.

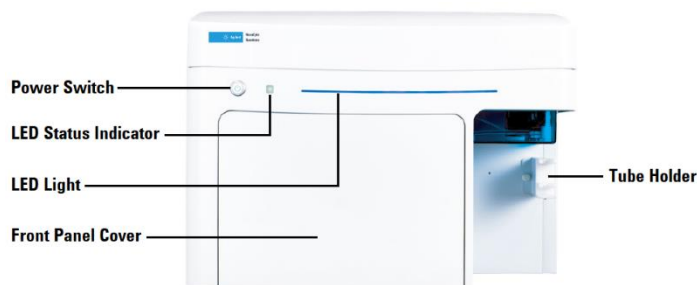

Figure 18. NovoCyte Quanteon Instrument (Front View)

The power switch turns the instrument on and off. The LED status indicator changes color to give direct visible indication of the instrument status. A detailed description of the status indicator is summarized in the following table.

Table 5 Power Switch Light and LED Status Indicator Information

Name	Color	Meaning
------	-------	---------

## Introduction

**Table 5 Power Switch Light and LED Status Indicator Information**

Power Switch Light	Steady green	Instrument is powered on.
	Flashing green	Instrument is performing the shutdown cleaning procedure.
LED Status Indicator	Green	Normal status.
	Orange	Warning. Click on the status bar in the NovoExpress software to review the warning message.
	Red	Errors. Click on the status bar in the NovoExpress software to review the error message.

### NOTE

If warnings or errors occur, follow the instructions in the prompted dialog box, and refer to [Troubleshooting](#) in this guide for troubleshooting methods.

The instrument back side (Figure 19) has a power port, four communication ports and five fluidic connection ports. The power port is used to supply the power to the instrument through provided power cord. The communication ports are used to communicate the instrument with NovoCyte Workstation, NovoCyte Fluidics Station II and other accessories (e.g. NovoSampler Q). The fluidics connection ports are used to connect the instrument with instrument reagent containers. Please refer to [Installation](#) in this guide for more details.

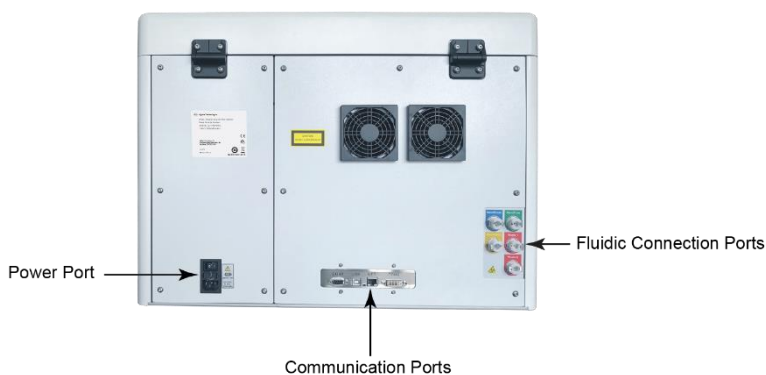

**Figure 19.** NovoCyte Quanteon Instrument (Rear View)

## NovoCyte Workstation and Monitor

NovoCyte Quanteon flow cytometer comes with NovoCyte Workstation (i.e. desktop or laptop computer), a monitor and associated accessories. Microsoft Windows operating system, Microsoft Office, and NovoExpress software are preinstalled on NovoCyte Workstation. For more details about the NovoCyte Workstation, please refer to the computer supplier's website. For details about the

## Introduction

operating system, please refer to the operating system help files. For NovoExpress software, please refer to [NovoExpress Software Guide](#).

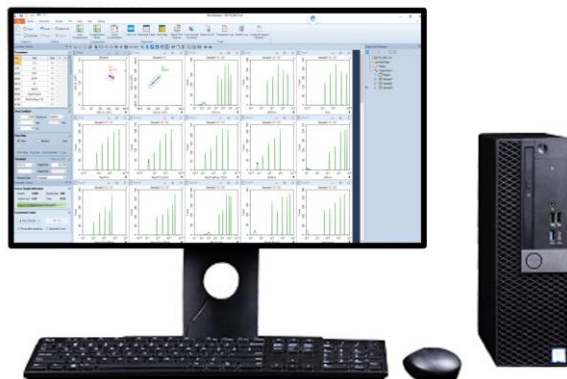

**Figure 20.** NovoCyt Workstation and Monitor

## NovoCyt Fluidics Station II

NovoCyt Quanteon flow cytometer comes with one NovoFlow sheath fluid container (3 L), one NovoRinse solution container (500 mL), one NovoClean solution container (500 mL), and one waste container (3 L) by default (Figure 21). The four containers should be placed in the designated positions on the supplied NovoCyt Fluidics Station II. Underneath each container there is a pressure sensor (Figure 22) to monitor the remaining liquid volume in real time, allowing the system to give a warning message when the fluid runs low or the waste is close to full.



**Figure 21.** NovoCyt Fluidics Station II

## Introduction

- NovoFlow sheath fluid: For hydrodynamically focusing the sample stream. Use 1X NovoFlow directly as sheath fluid or dilute 100X NovoFlow one hundred folds with 0.2 µm filtered, deionized water.
- NovoRinse solution: For rinsing and removing protein deposits, adherent cell debris, etc. in the fluidics system.
- NovoClean solution: For cleaning the fluidics system.

When the volume of NovoFlow sheath fluid, NovoRinse solution, or NovoClean solution is less than the set threshold (NovoFlow 0.9 L, NovoRinse 150 mL, NovoClean 150 mL), the NovoExpress software will prompt a warning message to remind the user to add the appropriate reagents. Similarly, when the waste volume exceeds a set threshold (2.8 L), the software will give a warning to remind the user to empty the waste container. The colors of the LED status indicator on the front of the NovoCyte Fluidics Station II also give information on the fluid level and are summarized in the following table.

**Table 6 NovoCyte Fluidics Station II LED Status Indicator Information**

Name	Color	Meaning
NovoCyte Fluidics Station II LED Status Indicator	Green	Reagent volume is above the designated threshold and is sufficient to run experiments (NovoFlow > 0.9 L; NovoRinse > 150 mL; NovoClean > 150 mL), and the waste container is not full (< 2.8 L).
	Orange	Reagent volume is below the threshold but is still sufficient to finish the current running experiment. (0.7 L < NovoFlow < 0.9 L; 100 mL < NovoRinse < 150 mL; 100 mL < NovoClean < 150 mL), or the waste container is close to full (2.8 L < waste < 3 L). Please add more reagents to the corresponding container or empty the waste container.
	Red	Reagent volume is too low to run experiments (NovoFlow < 0.7 L; NovoRinse < 100 mL; NovoClean < 100 mL), or the waste container is full (> 3 L). Any operation of the instrument is prohibited until there are enough reagents added or the waste container has been emptied.



## Introduction

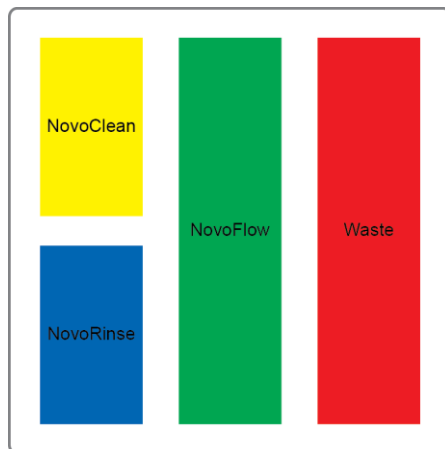

**Figure 22.** NovoCyte Fluidics Station II with Pressure Sensor underneath Each Reagent Container

### NOTE

Please ensure that the container position in the NovoCyte Fluidics Station II is correct (see Figure 22 and the label on the container). A similar label can be found on the left side of the NovoCyte Fluidics Station II as well. The containers are color coded to match the illustrated position as well.

### CAUTION

**Use caution to gently place the containers back into the NovoCyte Fluidics Station II to avoid damaging the pressure sensors.**

## NovoCyte Fluidics Cart (Optional)

Agilent flow cytometer can also be connected to optional NovoCyte Fluidics Cart with larger NovoFlow and Waste volume capacity. The NovoCyte Fluidics Cart comes with one NovoFlow sheath fluid container (15 L), one NovoRinse solution container (500 mL), one NovoClean solution container (500 mL), and one waste container (15 L). For ordering information, please visit [www.agilent.com](http://www.agilent.com) or contact Agilent sales representative. For details about NovoCyte Fluidics Cart, please refer to the [NovoCyte Fluidics Cart Operator's Guide](#).

## NovoSampler Q (Optional)

Agilent flow cytometer can also be connected to optional NovoSampler Q for automatic collection of multiple samples from a microtiter plate, or from 12 × 75 mm tubes using an Agilent Flow Cytometer 40 tube rack. For ordering information,

## Introduction

please visit [www.agilent.com](http://www.agilent.com) or contact Agilent sales representative. For details about the NovoSampler Q, please refer to the [NovoSampler Q Operator's Guide](#).

## 3 Installation

This chapter provides information on how to install NovoCyte Quanteon instrument and associated standard accessories, including installation warnings, space and environment requirements, instructions for lifting and carrying, and installation procedures.

### Installation Warnings

**WARNING** Ensure the instrument is powered off and is not connected to the workstation through the USB cable before installing or relocating the instrument.

---

**WARNING** Do not operate the instrument in an environment where potentially damaging liquids or gas are present.

---

**CAUTION** Please make sure the instrument is properly connected to the auxiliaries and reagent containers. Incorrect connections will result in damage to the instrument or cause operation failure.

---

**CAUTION** Do not loosen or remove any screws or parts other than those specifically described in the instructions for instrument installation or maintenance. Doing so may affect instrument performance and void the instrument warranty.

---

### Space Requirements

A minimum space of 150 cm (W) × 80 cm (D) × 90 cm (H) is required to install the NovoCyte Quanteon instrument and NovoCyte Fluidics Station II. Make sure there is at least 20 cm distance between the NovoCyte Quanteon instrument and the adjacent object (i.e. walls). Leave at least 10 cm distance between the NovoCyte Quanteon instrument and the NovoCyte Fluidics Station II.

### Environmental Requirements

NovoCyte Quanteon instrument is designed to be used indoor. Please install and operate the instrument with temperature of 15-32°C, and maximum relative humidity of 80%. Store the instrument with temperature of 1-40°C, and maximum relative humidity of 80%. Failure to follow the environmental requirements may reduce the operating lifetime or cause damage to the instruments.

### Instruction for Lifting and Carrying

- Do not attempt to lift or move the instrument without the assistance of others. Improper lifting can cause painful and permanent back injury. Depending on the weight of the instrument, moving or lifting the instrument may require two or more persons.
- Make sure to unplug the power adapter and disconnect the quick couplers of the instrument reagent containers from the back of the instrument. If the instrument is equipped with a NovoSampler Q, it needs to be uninstalled from the instrument. Do not move the instrument with the NovoSampler Q installed.
- Lift with two hands from the bottom of the instrument with at least one person at each side. Carefully move the instrument to the desired location and gently place it on a flat laboratory bench. Keep the instrument horizontal during the moving.
- If needed, proper lifting technique and appropriate moving equipment could be used to facilitate moving the instrument.

## Installation

### WARNING

To prevent accidents and to ensure the quality of the data, after Agilent Technologies professionals install the instrument, moving the instrument is not recommended. If any change of performance is observed, please contact your local Agilent Technologies representative.

## Install NovoCyte Quanteon

A complete and typical installation of NovoCyte Quanteon instrument requires installation of instrument, workstation, monitor, and NovoCyte Fluidics Station II. When NovoSampler Q or NovoCyte Fluidics Cart is purchased, user can refer to associated operator's guide for associated installation procedures.

Figure 23 illustrates the typical connection of the NovoCyte Quanteon flow cytometer system. Please follow the instructions below to install each component.

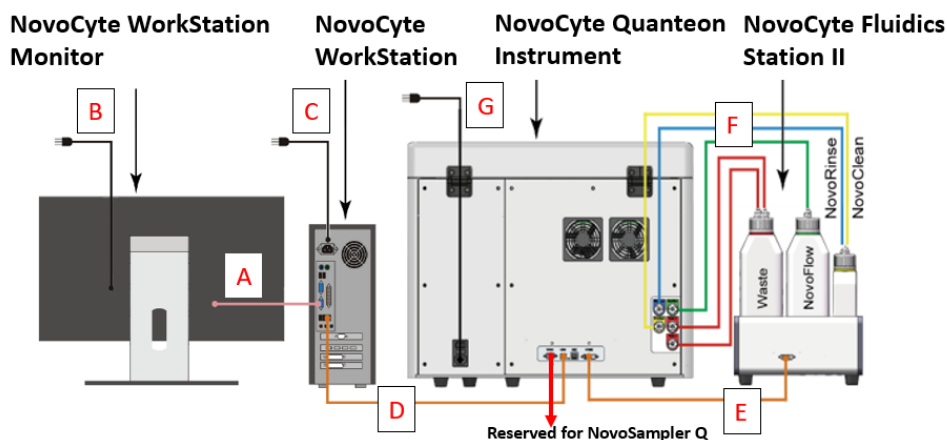

Figure 23. NovoCyte Quanteon flow cytometer System Connection

## Installation

### WARNING



Any peripheral accessories connected to NovoCyte Quanteon instrument need to meet SGS requirements outlined in UL 61010-1 and CAN/CSA-C 22.2 No. 61010-1-12 Safety Requirements for Electrical Equipment for Measurement, Control and Laboratory Use – Part 1: General Requirements.

### Connect NovoCyte Workstation

- 1 Connect the workstation to the monitor using the included DisplayPort to Mini DisplayPort cable (Connection A in Figure 23). Connect the DisplayPort end of the cable to the back of the workstation. Connect the Mini DisplayPort end to the monitor.
- 2 Connect the mouse and keyboard to any of the USB ports on the back of the workstation.
- 3 Use the supplied USB cable to connect the NovoCyte Quanteon flow cytometer to the USB port of the NovoCyte workstation (Connection D in Figure 23).

### NOTE

There are four communication ports at the back of NovoCyte Quanteon instrument (see Figure 24). COM 1 port connects to the NovoSampler Q (optional). COM 1 port connects to the NovoSampler Q (optional). USB port connects to the NovoCyte Workstation. COM 2 port connects to the NovoCyte Fluidics Station II through a DVI cable. The NET port is reserved for network connection.

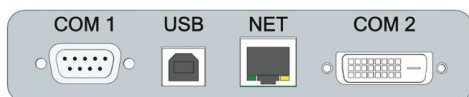

**Figure 24.** NovoCyte Quanteon Instrument Communication Ports

- 4 Connect the workstation and monitor to the power supply (Connections B and C in Figure 23). For more details, please refer to the instructions from the computer and monitor supplier.

### Connect NovoCyte Fluidics Station II

NovoCyte Fluidics Station II is connected to the COM 2 port of the NovoCyte Quanteon instrument through the supplied DVI cable (Connection E in Figure 23).

The connections for the reagent containers to the NovoCyte Quanteon instrument are shown in Figure 25. Five sets of tubing connect reagent containers on the

## Installation

NovoCyte Fluidics Station II to the ports at the back of the instrument. These ports are labeled with NovoRinse, NovoFlow, NovoClean, Waste 1, and Waste 2, respectively. NovoRinse is the rinsing solution and is connected by the blue tubing. NovoFlow is the sheath fluid and is connected by the green tubing. NovoClean is the decontamination solution and is connected by the yellow tubing. Waste 1 and Waste 2 connect to the red tubing.



**Figure 25.** Interface of the Fluidics Ports

The reagent containers are connected through the same color coded tubing to the ports at the back of the NovoCyte Quanteon instrument, as shown in Figure 26.



**Figure 26.** Tubing Connections of the Reagent Containers

### **Connect NovoCyte Fluidics Cart (Optional)**

Please refer to [NovoCyte Fluidics Cart Operator's Guide](#) for the detailed procedure.

### **Connect NovoSampler Q (Optional)**

Please refer to [NovoSampler Q Operator's Guide](#) for the detailed procedure.

## Installation

### Connect Instrument to Power Supply

Connect the NovoCyte Quanteon instrument to a power supply (100-240 VAC, 50-60Hz) by connecting one end of the supplied power cord to the power port on the instrument (Connection G in Figure 23), and connect the other end of the power cord to the power supply.

#### **WARNING**



**NovoCyte Quanteon Instrument is grounded through the power cord. Do not use any power cord without ground terminal. Do not use uncertified or detachable power cord.**

---



## 4 Instrument Operation

This chapter provides the procedures to operate NovoCyte Quanteon flow cytometer, including instrument startup, verify and modify instrument configuration, instrument QC test, and instrument shutdown.

### Instrument Start-up

#### Pre-Inspection

- 1 Check the power cords of the instrument and workstation and ensure that they are securely connected to a power outlet.
- 2 Check that the connection between the NovoCyte Fluidics Station II and the instrument are correct and secure.
- 3 Check that the connection between the NovoCyte Workstation and the instrument are correct and secure.
- 4 Check the NovoFlow sheath fluid container, the NovoRinse solution container, and the NovoClean solution container to make sure there are enough reagents inside. Follow the instructions described in [Add Instrument Reagents](#) in this guide to add more reagent to the container as needed.
- 5 Check the waste container to make sure the container is not full, follow the instructions described in [Empty Waste](#) in this guide to empty the waste container.

#### Power on the Instrument

Gently press the power switch on the front panel of the NovoCyte Quanteon flow cytometer to turn on the instrument. The power switch light should turn green, indicating that the instrument has entered the initialization process.

**WARNING** Unplug the power cord immediately under emergent situation (e.g. electric shock).

---

### NOTE



During the initialization process, the instrument conducts an automatic cleaning process, warms up the lasers, and prepares the instrument to be **Ready** for running samples.

### NOTE

User can also schedule automatic instrument power on or off at selected time and frequency by clicking **Schedule Power On & Off** from the Operation panel. Please refer to [NovoExpress Software Guide](#) for more details about this function.

---

## Turn on Workstation

- 1 Turn on the NovoCyte Workstation and monitor.
- 2 When ready, double-click the NovoExpress software icon  on the workstation desktop to launch NovoExpress software.
- 3 When prompted, select your username and log in. The software should display  **Initializing** on the status bar, which indicates that the instrument is properly connected, and that the instrument is in the initialization process. The initialization process takes several minutes. After completion, the status bar will display  **Ready**, indicating that the instrument is ready to use.



---

### NOTE

If the software displays a black icon  in the status bar, it means the instrument is not properly connected to the workstation. Check the USB cable between the instrument and the workstation and secure the connection. Then restart the NovoExpress software or workstation.

---

### NOTE

If more than one or multiple NovoExpress software is open on the NovoCyte Workstation with the instrument connected, only the software opened first will connect with the instrument when it is on. The other opened software will not connect with the instrument and the black icon  will be displayed in the status bar. If the instrument is turned on but you observed the black icon  in the NovoExpress status bar, check if there are multiple copies of NovoExpress software opened at the same time.

---

## Instrument Operation

### NOTE

The NovoExpress Software initially includes an **administrator** account. The default password for this account is **administrator**. The administrator login allows for creation of additional users and control of password settings. Please refer to the [NovoExpress Software Guide](#) for details.

---

### Add Instrument Reagents

If the reagent level is below 1/3 capacity on any reagent container, follow the instructions below to add more reagent to the container.

- 1 Make sure the instrument is in **Ready** status or the power is turned off.
- 2 Disconnect the tubing from the corresponding container by gently pressing the metal clip of the quick coupler on the cap.
- 3 Move the container from the NovoCyte Fluidics Station II to a sink. Unscrew the container cap and add more reagents.
- 4 Screw the container cap back onto the container.
- 5 Reconnect the quick coupler on the cap and gently place the container onto the NovoCyte Fluidics Station II. Be careful to prevent any twisting or kinking of the tubing.
- 6 Ensure the instrument is in **Ready** status, click the **Instrument > Fluidics Maintenance > Priming** on the NovoExpress software to prime the fluidics system before running any samples.

### NOTE

It's necessary to run **Priming** after adding instrument reagent. Otherwise the air introduced into tubings during adding reagent will influence the instrument performance.

### CAUTION

**Please make sure the instrument is in Ready status or powered off before adding any instrument reagents.**

---

### CAUTION

**Be sure to correctly connect the corresponding reagent container to the fluidics port on the back of the instrument. Incorrect connection will cause the instrument malfunction. The tubing and containers are color coded to prevent such errors.**

---

### CAUTION

**NovoCyte Fluidics Station II contains pressure sensors that may be damaged by spilled liquid. To prevent the risk of sensor damage, do not add reagent while the containers are on the NovoCyte Fluidics Station II.**

---

## Instrument Operation

### CAUTION

When adding reagents and emptying the waste, be sure to clean residual liquid on the outside of the containers and place the container onto the appropriate position in the NovoCyte Fluidics Station II.

### WARNING



Biological samples may be biohazardous. Appropriate personal protective equipment should be worn when handling the waste, which should be disposed of in accordance with local safety regulations.

## Empty Waste

If the waste container is more than 2/3 capacity, follow the instructions below to empty the waste container.

### NOTE

The procedures described below may vary if NovoCyte Fluidics Cart is used. Please refer to [NovoCyte Fluidics Cart Operator's Guide](#) for more details.

- 1 Make sure the instrument is in **Ready** status or the power is turned off.
- 2 Disconnect the tubing from the waste container by gently pressing the metal clip of the quick coupler on the cap.
- 3 Move the container from the NovoCyte Fluidics Station II to a sink. Unscrew the container cap and pour the waste to a tank for disposing of biohazardous materials.
- 4 Add 300 mL (i.e. 10% of total volume) bleach to the waste container.
- 5 Screw the container cap back onto the container.
- 6 Reconnect the quick coupler on the cap and place the container onto the NovoCyte Fluidics Station II. Be careful to prevent any twisting or kinking of the tubing.

### CAUTION

Please make sure the instrument is in **Ready** status or powered off before emptying the waste.

### WARNING



Biological samples may be biohazardous. Appropriate personal protective equipment should be worn when handling the waste, which should be disposed of in accordance with local safety regulations.

# Verify and Modify Instrument Configuration

Each Agilent flow cytometer may have more than one compatible optical configuration. It is recommended for users to view and verify the current optical configuration before each experiment. Users can also modify or customize their own optical configuration by replacing the appropriate optical filters of the system.

## View and Verify Instrument Configuration

- 1 Ensure NovoExpress software is launched and the instrument is in **Ready** status.
- 2 Click **Instrument** > **Configuration** to open the **Instrument Configuration** window.



**Figure 27.** Open Instrument Configuration Window

## Modify Instrument Configuration

To modify or customize the optical configuration, users need to replace the appropriate optical filters of the system following the prompt in the **Instrument Configuration** window. To make the new optical configuration effective, a QC Test with automatic adjustment of photodetector gain will be performed to optimize instrument performance. This function provides user with more flexibility and convenience to match instrument optical configuration with specific fluorochrome panel.

Please follow the instructions below to modify the instrument optical configuration.

### NOTE

All figures below are used for illustration purpose only. Certain fluorescence detection channels, bandpass filters or dichroic mirrors may not be included in your NovoCyte Quanteon system. Please consult with your local Agilent sales representatives or distributors for more details.

- 1 Ensure the instrument is properly connected and powered on. Enable the **Customize Optical Configuration** in the **Access Privilege** window for the

## Instrument Operation

current user account by following the instructions described in [Access Privilege in NovoExpress Software Guide](#).

- Click **Instrument** > **Configuration** to open the **Instrument Configuration** window. Click **Create Copy** in the **Instrument Configuration** window to generate an editable copy of the configuration. Click **Rename** to rename the configuration if needed. Click **Change Optical Configuration** to continue.

### NOTE

A customized optical configuration can be deleted by clicking **Delete**. Only the user-defined optical configurations can be deleted.

Par...	Excit...	Detecto...	Default Alias
B525	488	525/45	FITC
B586	488	586/20	EYFP
B615	488	615/20	PI
B667	488	667/30	PerCP
B695	488	695/40	PerCP-Cy5.5
B725	488	725/40	PerCP-eFluor 7...
B780	488	780/60	PE-Cy7 (B)
R667	637	667/30	APC
R695	637	695/40	Alexa Fluor 680
R725	637	725/40	Alexa Fluor 700
R780	637	780/60	APC-Cy7
V445	405	445/45	Pacific Blue
V525	405	525/45	AmCyan
V586	405	586/20	Pacific Orange
V615	405	615/20	Qdot 605
V667	405	667/30	Qdot 655
V695	405	695/40	Qdot 705
V725	405	725/40	BV711
V780	405	780/60	Qdot 800
Y586	561	586/20	PE
Y615	561	615/20	PE-Texas Red
Y667	561	667/30	PE-Cy5
Y695	561	695/40	PE-Cy5.5
Y725	561	725/40	PE-Alexa Fluor...

**Figure 28.** Customize the Instrument Configuration

- Open the top cover of the instrument. Insert one end of the Allen wrench through the hole. Gently hold the proper optical filter or dichroic mirror and pull it upward to remove it from the slot. Insert the new optical filter or dichroic mirror back into the slot as shown in the following figure. Close the top cover of the instrument.

## Instrument Operation



**Figure 29.** Change the Optical Filter or Dichroic Mirror

- Click **Complete**. The software will automatically read and check the validity of the new optical configuration.

Instrument Configuration (Automatically Detected)

Instrument: NovoCyte Quanteon    Optical Configuration: User-Defined    [Rename](#)    [Create Copy](#)    [Delete](#)

Make sure the optical filters and mirrors have been replaced with the correct ones. Click Complete to complete the procedure.

Par...	Excit...	Detecto...	Default Alias
B525	488	525 / 45	FITC
B586	488	586 / 20	EYFP
B615	488	615 / 20	PI
B667	488	667 / 30	PerCP
B695	488	695 / 40	PerCP-Cy5.5
B725	488	725 / 40	PerCP-eFluor 7...
B780	488	780 / 60	PE-Cy7 (B)
R667	637	667 / 30	APC
R695	637	695 / 40	Alexa Fluor 680
R725	637	725 / 40	Alexa Fluor 700
R780	637	780 / 60	APC-Cy7
V445	405	445 / 45	Pacific Blue
V525	405	525 / 45	AmCyan
V586	405	586 / 20	Pacific Orange
V615	405	615 / 20	Qdot 605
V667	405	667 / 30	Qdot 655
V695	405	695 / 40	Qdot 705
V725	405	725 / 40	BV711
V780	405	780 / 60	Qdot 800
Y586	561	586 / 20	PE
Y615	561	615 / 20	PE-Texas Red
Y667	561	667 / 30	PE-Cy5
Y695	561	695 / 40	PE-Cy5.5
Y725	561	725 / 40	PE-Alexa Fluor...

 At the bottom of the window, there are buttons for 'Complete', 'OK', and 'Cancel'. A checkbox for 'NovoSampler Q installed' is also present."/>

**Figure 30.** Complete Modifying the Optical Configuration

- Click **OK** to confirm the new configuration.

## Instrument Operation

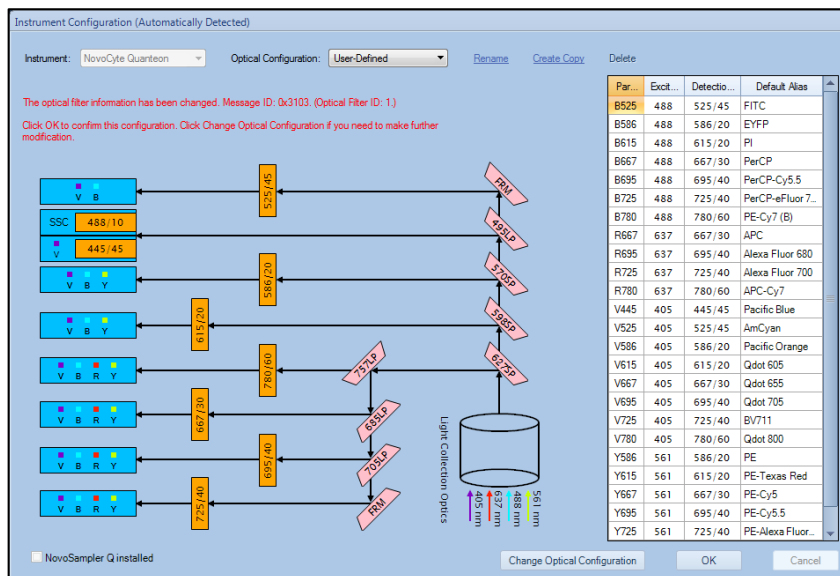

Figure 31. Confirm the New Optical Configuration

### NOTE

If the new optical configuration is invalid, there will be message in **Instrument Configuration** window.

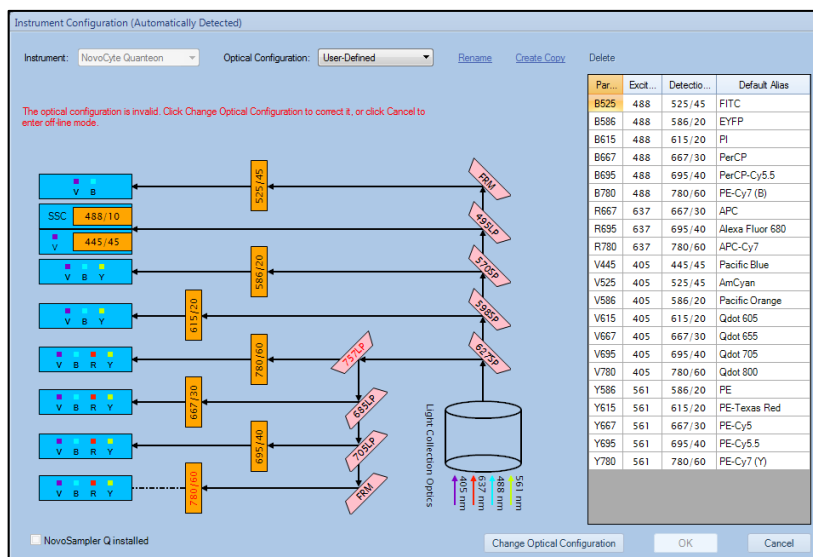
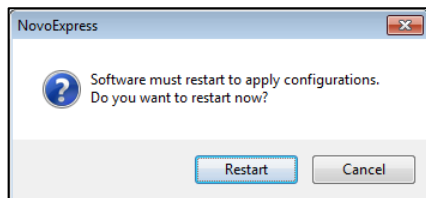

Figure 32. Dialog Window for Invalid Optical Configuration



## Instrument Operation

- Click **Restart** in the next window to restart the software to apply the new optical configuration setting.



**Figure 33.** Dialog Window for Restarting the NovoExpress

- After NovoExpress is restarted, the following window will appear. Click **QC Test** to continue.

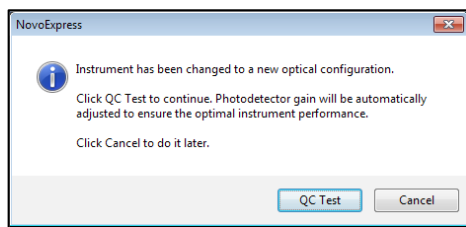

**Figure 34.** Dialog Window for Performing the QC Test

- Properly prepare 1 mL QC particles sample as described in [NovoExpress Software Guide](#). Place the sample tube in the tube holder or NovoSampler Q. Fill in the test information in the pop-up window. Click **Next** to continue.

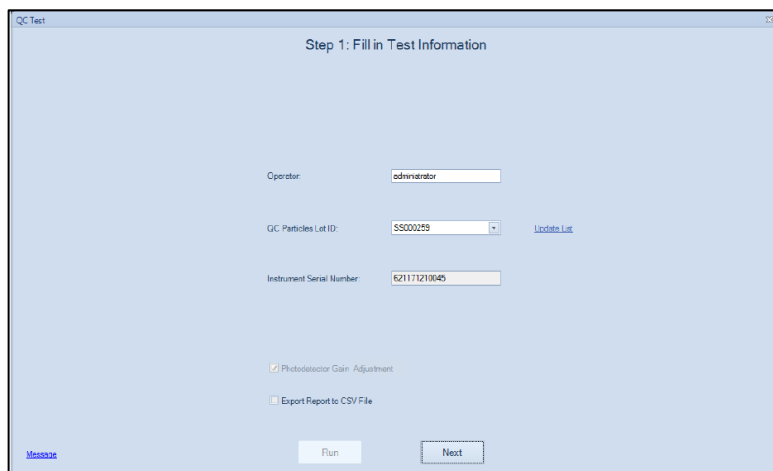
A screenshot of a "QC Test" window titled "Step 1: Fill in Test Information". The form contains the following fields and options:

- Operator: administrator
- QC Particles Lot ID: S5000259 (with a dropdown arrow and a "Locate Lot" link)
- Instrument Serial Number: 621171210045
- Photodetector Gain Adjustment:
- Export Report to CSV File:

At the bottom, there are "Run" and "Next" buttons. A "Massa" logo is visible in the bottom left corner.

**Figure 35.** Fill in the Test Information

## Instrument Operation

- 9 Ensure all the test information is correct and the sample tube is properly installed on the tube holder, click **Run** to start. The software will automatically adjust the photodetector gain by running the QC particles. When the adjustment is completed, the software will automatically perform the QC Test. Click **Report** when the QC test is completed.

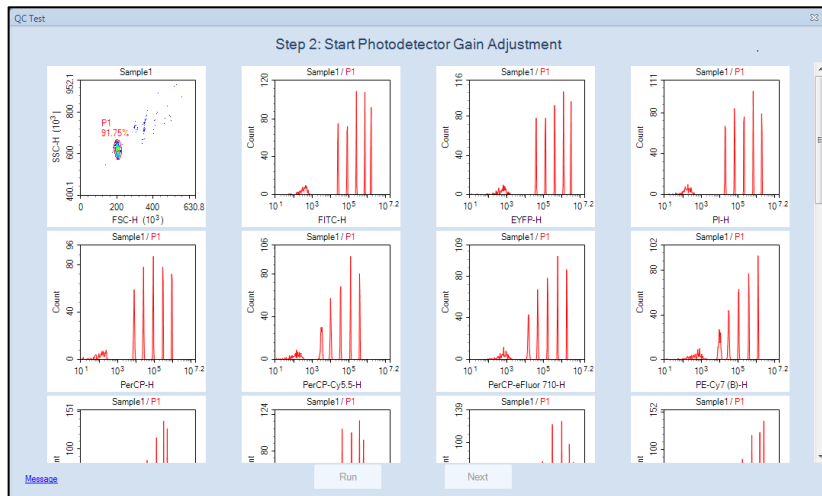

Figure 36. Adjust the Photodetector Gain

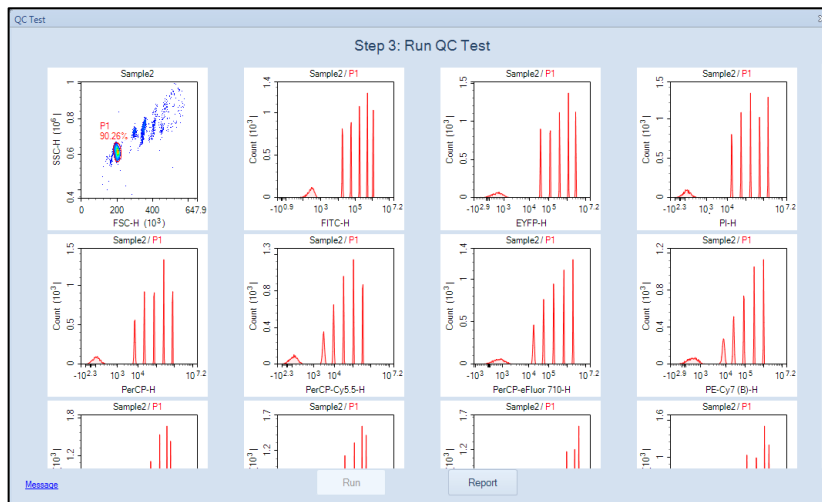

Figure 37. Running QC Test

- 10 Ensure the result shows **Pass** for all the channels. Click **Finish** to close the window and complete the optical configuration modification.

## Instrument Operation

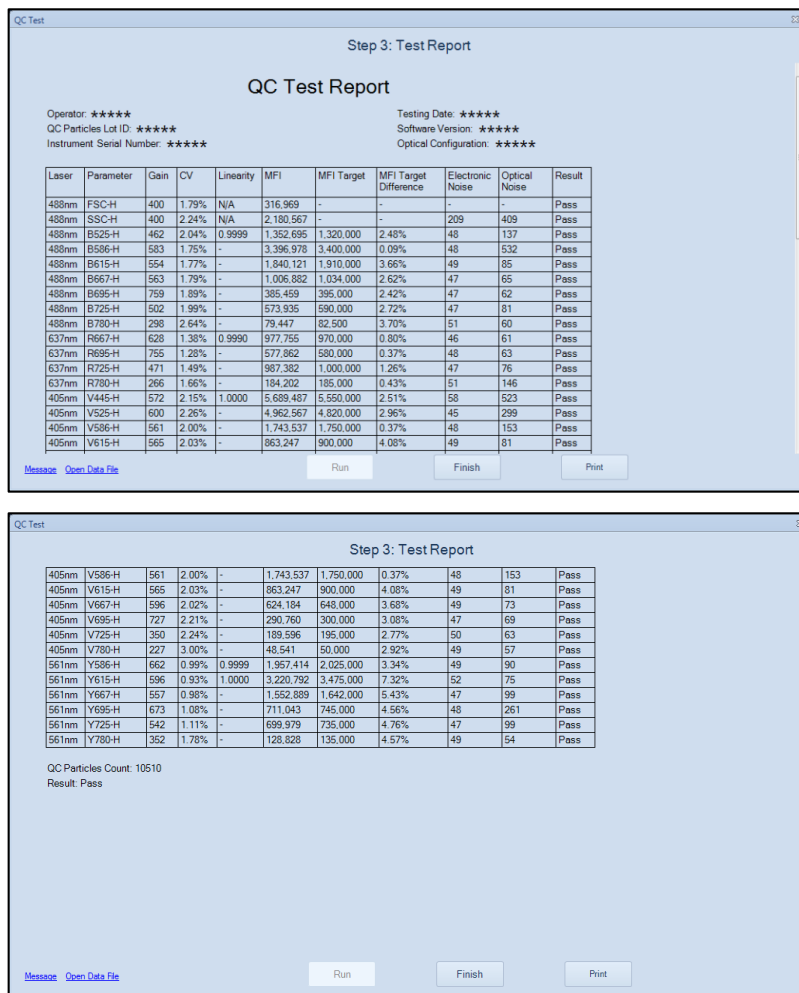

Figure 38. View the QC Test Result

### NOTE

If the result of certain detection channels shows **Acceptable** or **Failed** as below, make sure the QC particles are properly prepared. Run the QC particles once again after the correct action has been taken. Ensure there is at least 400  $\mu$ L sample remaining in the sample tube. Click **Repeat Test** to repeat the QC test. The photodetector gain will be automatically re-adjusted.

### NOTE

Please contact Agilent technical support if the QC test failed for three times in a row.

## Instrument Operation

QC Test

Step 3: Test Report

637nm	R667-H	628	1.35%	0.9990	979.341	970.000	0.96%	46	63	Pass
637nm	R695-H	755	1.30%	-	579.505	580.000	0.09%	48	66	Pass
637nm	R725-H	471	111.40%	-	66	1,000.000	99.99%	47	58	Failed
637nm	R780-H	286	1.70%	-	185.213	185.000	0.12%	51	152	Pass
405nm	V445-H	572	2.32%	1.0000	5.673.781	5.550.000	2.23%	57	477	Pass
405nm	V525-H	600	2.40%	-	4.960.254	4.820.000	2.91%	46	102	Pass
405nm	V586-H	561	2.13%	-	1.742.787	1,750.000	0.41%	47	70	Pass
405nm	V615-H	565	2.15%	-	864.178	900.000	3.98%	49	55	Pass
405nm	V687-H	596	2.12%	-	625.388	648.000	3.49%	48	57	Pass
405nm	V695-H	727	2.33%	-	292.335	300.000	2.55%	47	64	Pass
405nm	V725-H	350	115.31%	-	62	195.000	99.97%	50	54	Failed
405nm	V780-H	227	3.00%	-	48.845	50.000	2.31%	50	59	Pass
561nm	Y586-H	662	1.05%	0.9999	1.957.832	2,025.000	3.32%	49	93	Pass
561nm	Y615-H	596	0.97%	1.0000	3,215.625	3,475.000	7.46%	52	82	Pass
561nm	Y667-H	557	1.04%	-	1,553.286	1,642.000	5.40%	48	105	Pass
561nm	Y695-H	673	1.14%	-	714.272	745.000	4.12%	46	267	Pass
561nm	Y725-H	542	117.06%	-	62	735.000	99.99%	47	55	Failed
561nm	Y780-H	352	1.74%	-	128.748	135.000	4.63%	49	63	Pass

QC Particles Count: 10595  
Result: Failed

Failed Reason: The CV of following parameters exceeds its threshold: B725-H, R725-H, V725-H, Y725-H  
The MFI target differences of following parameters are not in the acceptable range: B725-H, R725-H, V725-H, Y725-H.

[Message](#) [Open Data File](#)

Figure 39. Test Report Indicating Failed QC Test

## Instrument QC Test

QC test is an Instrument Quality Control (QC) procedure which is used to monitor the performance of the instrument and prevents any tests being conducted under non-optimal instrument conditions. It is recommended to run the QC test right after the installation and on a daily basis to ensure the consistency of the instrument performance. Please refer to [NovoExpress Software Guide](#) for detailed instructions.

## Instrument Shutdown

At the end of the day, or when all the tests are completed, please shut down the instrument by following the procedure described below.

### NOTE

User can also schedule automatic instrument power on or off at selected time with defined frequency by clicking **Schedule Power On & Off** from the **Operation** panel. Please refer to [NovoExpress Software Guide](#) for more details about this function.

- 1 Turn off the Instrument

## Instrument Operation

Gently press the power switch on the front panel of the instrument or click the **Instrument** > **Shut Down** icon on the NovoExpress software. During the shutdown process, the power switch light will be flashing green, and the instrument will automatically perform the shutdown cleaning process. After the shutdown process is completed, power is automatically turned off and the power switch light goes out.

### NOTE

When shutdown is initiated from NovoExpress software, if no additional function option is selected, the instrument automatically performs the shutdown cleaning process and turns off the power, and no user interference is needed. If additional function option is selected, please refer to [Clean the Sample Injection Probe \(SIP\)](#) in this guide for more information.

- 2 Turn off the NovoCytte Workstation.
- 3 Follow the instructions described in [Add Instrument Reagents](#) in this guide to add more reagent to NovoFlow, NovoClean and NovoRinse containers.
- 4 Follow the instructions described in [Empty Waste](#) in this guide to Empty the waste container.

This page is intentionally left blank.

## 5 Running Samples

This chapter describes the typical procedures of running examples on NovoCyte Quanteon instrument using human peripheral blood lymphocyte subsets analysis as an example.

### Overview

This test uses the Agilent CD3 FITC/CD8 PE/CD45 PerCP/CD4 APC Reagent and the Agilent CD3 FITC/CD16+CD56 PE/CD45 PerCP/CD19 APC Reagent to stain human peripheral blood lymphocyte subpopulations. The kit contains two sets of four-color antibodies, which are CD3 FITC/CD8 PE/CD45 PerCP/CD4 APC and CD3 FITC/CD16 +CD56 PE/CD45 PerCP/CD19 APC respectively. For a detailed description of the reagents and sample preparation process, please refer to the reagent technical data sheet.

#### NOTE

The fluorescence channel configuration varies for different instrument models. Please refer to [Appendix A](#) in this guide for optical configuration of your product.

This example will create a specimen named **human peripheral blood**, which consists of two tubes of human peripheral blood samples prepared and stained respectively by the Agilent CD3 FITC/CD8 PE/CD45 PerCP/CD4 APC Reagent and the Agilent CD3 FITC/CD16+CD56 PE/CD45 PerCP/CD19 APC Reagent. The test needs to use 488 nm, 561nm and 637 nm lasers, and collect signals of the Height and Area parameters on FSC, SSC, and the fluorescent channels including B525 (FITC), Y586 (PE), B667 (PerCP), and R667 (APC). Each sample will be collected at a **Slow** sample flow rate until the events reach 5,000 in the Lymphocyte gate.

This chapter describes the entire sample collection and data analysis processes.

- Create Experiment
- Define Sample Acquisition Parameters
- Set Sample Acquisition Conditions
- Run Sample

## Running Samples

- Perform Fluorescence Compensation
- Analyze Data
- Append Data
- Delete Data
- Save Data
- Import and Export Files

## Create Experiment

Click the NovoExpress software icon on the Desktop or click **Start > Program > NovoExpress** to start the NovoExpress software.

Once the NovoExpress software has started, a new NovoCyte Quanteon experiment file with the default file name of **untitled.ncf** will be created. The extension name of **.ncf** indicates that the file is a NovoCyte Quanteon experiment file. Click the **Next Sample** button on **Cytometer Control** panel to create a new sample to start the experiment.

Figure 40 shows the NovoExpress software interface. The status bar indicates that the instrument is properly connected and is **Ready** to use. The **Experiment Manager** displays **untitled.ncf** as a new experiment file. Click the menu **File > Save** or  icon to save the file to the specified folder. When you save, the NovoExpress software will name the file according to the date and time when the file is created, with a default format of **yymmdd\_hhmm.ncf**. For example, a **180608\_1035.ncf** file indicates that the file is generated at 10:35 on December 8, 2018. Users can change the file name and the directory when saving the experiment file. In this example, an experiment file with the name of **TBNK.ncf** will be created.



## Running Samples

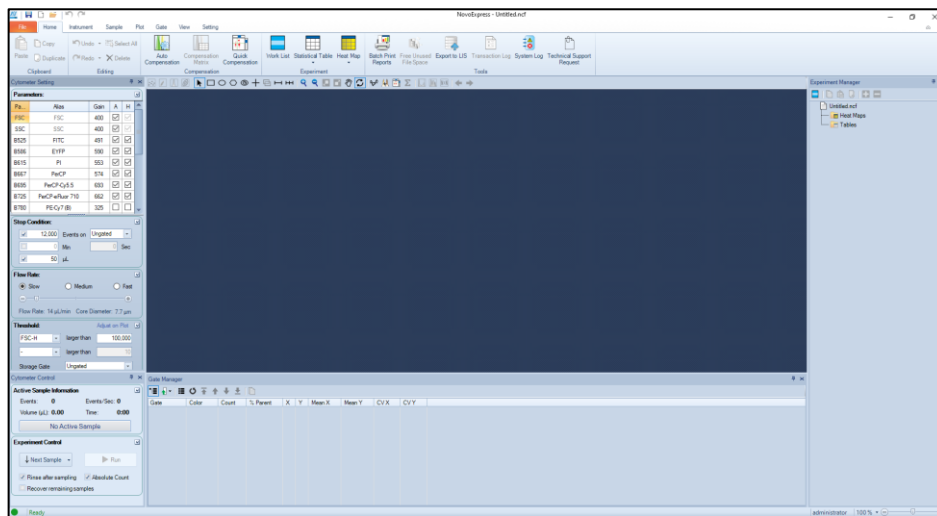

Figure 40. NovoExpress Software Interface

Click the **Next Sample** button on **Cytometer Control** panel, or right-click the file name **TBNK.ncf** on **Experiment Manager** panel and select **New Sample** from the drop-down menu, to create a new sample to start the experiment. After that, one specimen with the default name **Specimen 1** contains one sample with the default name **Sample 1** will be created. In this example, two samples prepared and stained by two reagent kits need to be created. Repeat creating a new sample to add **Sample 2** to the same specimen. Rename specimen and sample name by click the name twice or select **Rename** on the right-click drop-down menu. In this example, rename **Specimen 1** as **TBNK**, rename **Sample 1** to **T-Lym** and **Sample 2** to **NKB**.

### NOTE

A hierarchic tree structure is used in the **Experiment Manager** for effective organization of the experimental data. You can use **Group**, **Specimen**, and **Sample** to organize your experiments and name them in a systematic way to improve the efficiency and traceability of experimental results. For more information, please refer to the [NovoExpress Software Guide](#).

After the above operation, the **Experiment Manager** will appear as shown in Figure 41.

## Running Samples

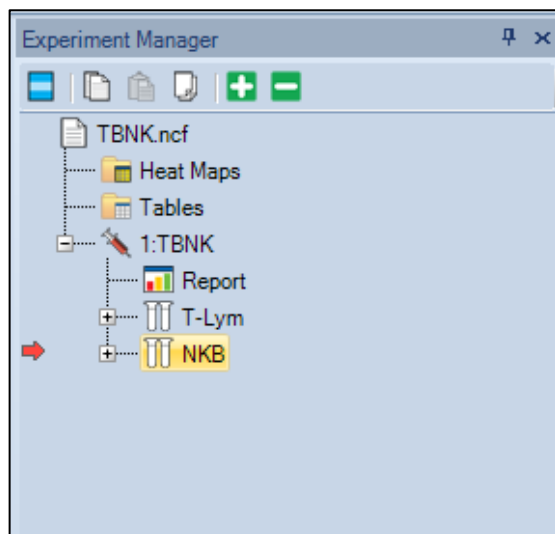

Figure 41. Experiment Manager

### NOTE

The red arrow on the left of a sample in the **Experiment Manager** indicates this sample is the **Active Sample**. A sample can be designated as the **Active Sample** by double-clicking the sample in the **Experiment Manager**.

### NOTE

Please refer to the [NovoExpress Software Guide](#) for details about creating Group, Specimen, and Sample.

## Define Sample Acquisition Parameters

- 1 Double-click the **T-Lym** sample to make it the **Active Sample**.
- 2 Set the test parameters in the **Cytometer Setting > Parameters** panel (see Figure 42). By default, the **Height** parameters of FSC and SSC signals are always selected. Either **Area** or **Height** or both can be selected for fluorescent channels to be used in the experiment. In this example, select **FSC, SSC, B525, Y586, B667, R667 Height** and **Area** as detection parameters.
- 3 Click the **Alias** area in the corresponding fluorescent channels to name the detection channel with the name of the fluorophores. In this example, rename

## Running Samples

**B525, Y586, B667, and R667** to be **CD3 FITC, CD8 PE, CD45 PerCP, and CD4 APC**, respectively.

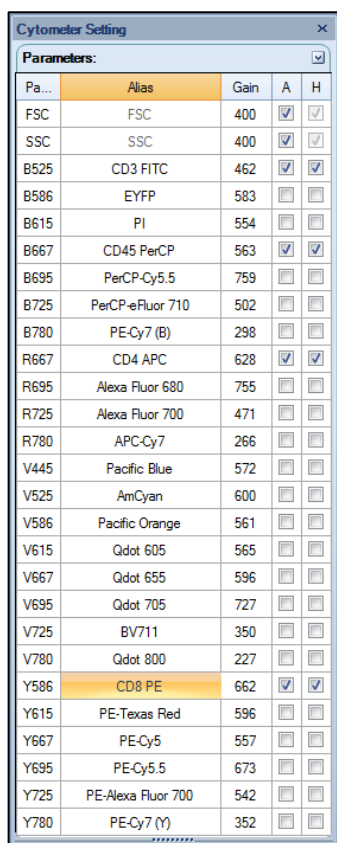

Pa...	Alias	Gain	A	H
FSC	FSC	400	<input checked="" type="checkbox"/>	<input checked="" type="checkbox"/>
SSC	SSC	400	<input checked="" type="checkbox"/>	<input checked="" type="checkbox"/>
B525	CD3 FITC	462	<input checked="" type="checkbox"/>	<input checked="" type="checkbox"/>
B586	EYFP	583	<input type="checkbox"/>	<input type="checkbox"/>
B615	PI	554	<input type="checkbox"/>	<input type="checkbox"/>
B667	CD45 PerCP	563	<input checked="" type="checkbox"/>	<input checked="" type="checkbox"/>
B695	PerCP-Cy5.5	759	<input type="checkbox"/>	<input type="checkbox"/>
B725	PerCP-eFluor 710	502	<input type="checkbox"/>	<input type="checkbox"/>
B780	PE-Cy7 (B)	298	<input type="checkbox"/>	<input type="checkbox"/>
R667	CD4 APC	628	<input checked="" type="checkbox"/>	<input checked="" type="checkbox"/>
R695	Alexa Fluor 680	755	<input type="checkbox"/>	<input type="checkbox"/>
R725	Alexa Fluor 700	471	<input type="checkbox"/>	<input type="checkbox"/>
R780	APC-Cy7	266	<input type="checkbox"/>	<input type="checkbox"/>
V445	Pacific Blue	572	<input type="checkbox"/>	<input type="checkbox"/>
V525	AmCyan	600	<input type="checkbox"/>	<input type="checkbox"/>
V586	Pacific Orange	561	<input type="checkbox"/>	<input type="checkbox"/>
V615	Qdot 605	565	<input type="checkbox"/>	<input type="checkbox"/>
V667	Qdot 655	596	<input type="checkbox"/>	<input type="checkbox"/>
V695	Qdot 705	727	<input type="checkbox"/>	<input type="checkbox"/>
V725	BV711	350	<input type="checkbox"/>	<input type="checkbox"/>
V780	Qdot 800	227	<input type="checkbox"/>	<input type="checkbox"/>
Y586	CD8 PE	662	<input checked="" type="checkbox"/>	<input checked="" type="checkbox"/>
Y615	PE-Texas Red	596	<input type="checkbox"/>	<input type="checkbox"/>
Y667	PE-Cy5	557	<input type="checkbox"/>	<input type="checkbox"/>
Y695	PE-Cy5.5	673	<input type="checkbox"/>	<input type="checkbox"/>
Y725	PE-Alexa Fluor 700	542	<input type="checkbox"/>	<input type="checkbox"/>
Y780	PE-Cy7 (Y)	352	<input type="checkbox"/>	<input type="checkbox"/>

**Figure 42.** Define Sample Acquisition Parameters

### NOTE

Parameters that are not selected in the **Parameters** setting panel will not be collected in the data, and therefore will not be available for data analysis. However, selecting too many parameters other than those really needed in the experiment will unnecessarily increase the size of the experiment file, causing decreased data processing speed. Before doing an experiment, the parameters should be set appropriately, in order to avoid incomplete data collection or slow software data processing speed.

### NOTE

After the system has started collecting samples, only the **Alias** of the parameters can be edited. Selection or de-selection of parameters is not allowed.

## Running Samples

### NOTE

The set of parameters available in the **Parameters** panel is dependent on the model of NovoCyte Quanteon flow cytometer. The software will automatically identify the instrument configuration and detect the available channels to be shown in **Cytometer Setting > Parameters** panel.

### NOTE

De-selection of parameters that are not used in the experiment will help to reduce the size of the experiment file, and thus improve the data analysis speed.

### NOTE

The **Gain** column shows photodetector gains of all fluorescent channels. NovoCyte Quanteon uses fixed photodetector gain by default. Adjustable photodetector gain is available as advanced function. Please refer to the [NovoExpress Software Guide](#) for details about photodetector gain adjustment.

## Set Sample Acquisition Conditions

### Stop Condition

The criteria to stop sample acquisition can be set in **Cytometer Setting > Stop Condition** panel (Figure 43), based on either the number of events to be collected (all events or within a specified gate), a time limit, or a sample volume limit. Multiple stop conditions can be selected as well. When any one of these conditions is met, the instrument will stop collecting samples. The number of events to be collected may be modified during the sample collection process. However, the time or volume stop conditions cannot be modified.

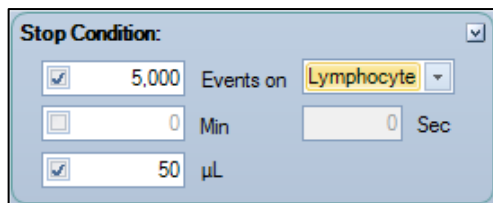

The screenshot shows the 'Stop Condition' panel with the following settings:

- 5,000 Events on **Lymphocyte**
- 0 Min
- 0 Sec
- 50  $\mu$ L

Figure 43. Set Stop Condition

## Running Samples

### NOTE

For a new experiment, it is difficult to determine when to stop collecting. In this case, first try a small volume as the stop condition (for example, 10  $\mu\text{L}$ ) for a pre-run. The results of the pre-run could serve as a guide to set the stop conditions for the real experiment. In the examples in this guide, 5,000 events within the **Lymphocyte** gate and 50  $\mu\text{L}$  will be used as the stop condition. Details on how to set the **Lymphocyte** gate is described in **Data Analysis** in this chapter.

## Flow Rate

Sample flow rate can be set in the **Cytometer Setting > Flow Rate** panel. There are three preset flow rates, **Slow**, **Medium** and **Fast**, corresponding to sample flow rates of 14  $\mu\text{L}/\text{min}$ , 35  $\mu\text{L}/\text{min}$  and 66  $\mu\text{L}/\text{min}$ , respectively. You can also manually set a desired flow rate within the range of 5  $\mu\text{L}/\text{min}$  to 120  $\mu\text{L}/\text{min}$  by adjusting the sliding bar. Different sample flow rates correspond to different core diameters of hydrodynamic focusing. Choosing a proper flow rate is critical to the quality of the data, and a few factors should be considered, such as the size of the cells, the resolution to be achieved, the concentration of the sample, the throughput, etc. In general, it is advisable to choose a core diameter that is similar or slightly larger than the size of the cells. The Slow flow rate is always recommended for an experiment that requires high resolution, for example, DNA content analysis. For experiments where the resolution is not so critical, Medium, or even Fast flow rate can be used in order to increase the throughput, especially when the concentration of the sample is relatively low. In the example in this guide, the Slow flow rate will be used.

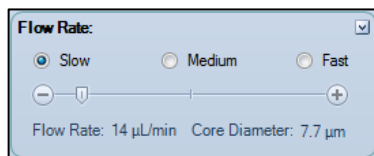

**Figure 44.** Set the Sample Flow Rate

## Threshold

Threshold can be set in the **Cytometer Settings > Threshold** panel or through **Adjust on Plot** (Figure 45). The threshold sets a limit so that only the data values that are higher than this limit will be processed and recorded. Appropriate threshold settings improve the efficiency for collection of target particles while excluding debris and background noise, or other particles that are not relevant to the experiment. Two thresholds can be set at the same time. The primary threshold is based on FSC-H (Height of FSC signal) or SSC-H (Height of SSC signal) or Fluorescent signal Height at available channels, while the second

## Running Samples

threshold can be based on any one of the parameters set under the **Cytometer Settings > Threshold** panel. When two threshold conditions are set, data will be collected only from particles with signal intensities meeting both thresholds.

The Storage Gate is used to filter out events outside the gate. All events above the primary and secondary threshold will be recorded when Storage Gate is set to Ungated. In the example in this guide, the primary threshold is set to FSC-H greater than 100,000, the second threshold is left blank and the Storage Gate is set to Ungated.

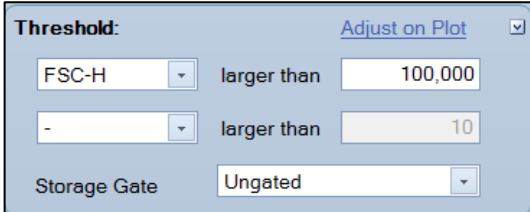

The screenshot shows a software interface for setting a threshold. The panel is titled "Threshold:" and has a blue background. At the top right, there is a button labeled "Adjust on Plot" with a small downward arrow. Below this, there are two rows of threshold settings. The first row shows a dropdown menu with "FSC-H" selected, followed by the text "larger than", and a text input field containing "100,000". The second row shows a dropdown menu with "-" selected, followed by "larger than", and a text input field containing "10". At the bottom of the panel, there is a label "Storage Gate" followed by a dropdown menu with "Ungated" selected.

**Figure 45.** Set the Threshold

### NOTE

During data acquisition, the threshold can be adjusted after clicking the **Adjust on Plot** tab. The threshold will be set to the new value when clicking the desired position on the plot for the subsequent data acquisition.

### NOTE

For a new experiment, it might be difficult to determine how to set the threshold. In this case, conduct a pre-run with threshold adjusted on the plot to determine where the cell population of interest is in the FSC-H/SSC-H plot. The pre-run results should serve as a good guide for setting the proper threshold for the next experiment. In the example in this guide, the distribution of the leukocytes (lymphocytes, monocytes, granulocytes) relative to the lysed red blood cells and debris should be observed. Adjust the FSC-H threshold value until the majority of the lysed red blood cells and debris are discarded, but the leukocytes are not affected. Set this threshold in the **Threshold** panel for the real experiment.

### NOTE

For new experiments, a pre-run helps to optimize the cytometer settings and determine the most appropriate experimental conditions, including the **Stop Condition**, **Flow Rate**, and **Threshold**.

## Running Samples

### NOTE

In the example in this guide, setting the FSC-H threshold as 100,000 ensures the correct collection of the leukocyte signals, and effectively discards most of the impurities. Refer to Table 7 as a starting point for setting the threshold for different biological samples. Table 8 serves as a reference to determine which threshold value to start from based on microsphere size. Some biological samples may contain a significant amount of impurities or debris. In this case, setting a second threshold with a fluorescent signal helps to improve the quality of the collected data.

**Table 7 Recommended Threshold for Different Cell Types**

Cell Types	FSC-H Threshold	Remark
Cell lines, larger than 20 $\mu\text{m}$ in cell diameter	300,000~1,000,000	Use linear or logarithmic scale for FSC and SSC
Cells lines, smaller than 20 $\mu\text{m}$ in cell diameter	100,000~300,000	Use linear or logarithmic scale for FSC and SSC
Fixed or un-fixed, freshly isolated cells (leukocytes, spleen cells, thymocytes)	50,000~200,000	Use linear or logarithmic scale for FSC and SSC
Platelets	5,000~10,000	Use logarithmic scale for FSC and SSC
Bacteria	1,000~10,000	Use logarithmic scale for FSC and SSC. Recommend to use SSC-H > 5,000 as the second threshold.

**Table 8 Reference Threshold for Different Size of Standard Polystyrene Microspheres**

Standard Microsphere Diameter	Threshold
0.1 $\mu\text{m}$	SSC-H 700 (increase the gain of SSC to improve the resolution)
0.2 $\mu\text{m}$	SSC-H 1,000
0.5 $\mu\text{m}$	FSC-H 500
2 $\mu\text{m}$	FSC-H 50,000
>10 $\mu\text{m}$	FSC-H 500,000

### NOTE

To detect microsphere with 0.1  $\mu\text{m}$  diameter, the photodetector gain of SSC needs to be increased. Please refer to [Parameter Settings](#) in [NovoExpress Software Guide](#) for instructions and more details on adjusting the photodetector gain.

## Run Sample

There are two samples for the example in this guide. Double-click each sample to make it to be the Active Sample (red arrow shown on the left of the sample). Define the collection parameters and set the acquisition conditions for the two samples as shown in Figure 46.

The Instrument Settings Panel is divided into three sections:

- Stop Condition:**
  - 5,000 Events on Lymphocyte
  - 0 Min  0 Sec
  - 50  $\mu$ L
- Flow Rate:**
  - Slow  Medium  Fast
  - Flow Rate: 14  $\mu$ L/min Core Diameter: 7.7  $\mu$ m
- Threshold:**
  - Adjust on Plot
  - FSC-H larger than 100,000
  - larger than 1,000
  - Storage Gate: Ungated

Figure 46. Instrument Settings Panel

After setting the acquisition parameters and acquisition conditions, double-click the **T-Lym** sample and set it as the Active Sample in the Experiment Manager. A red arrow will appear to the left of the sample, indicating it is the Active Sample. At the same time, the sample name in **Cytometer Control > Active Sample Information** panel becomes **T-Lym**. To begin collecting this sample, place the **CD3 FITC/CD8 PE/CD45 PerCP/CD4 APC** sample tube into the sample holder on the NovoCyte Quanteon flow cytometer. Then click the Run button in the **Cytometer Control > Experiment Control** panel to start sample acquisition (Figure 47). At this time, the sample injection probe will move downward to aspirate the sample. After a short period of time for stabilizing the fluidic system, sample acquisition and data collection will start. During the data acquisition, the **Restart** button will appear in the **Experiment Control** panel. Clicking this button will delete all collected events, reset the collection time and volume in the **Active Sample Information** panel, and restart the data collection.



## Running Samples

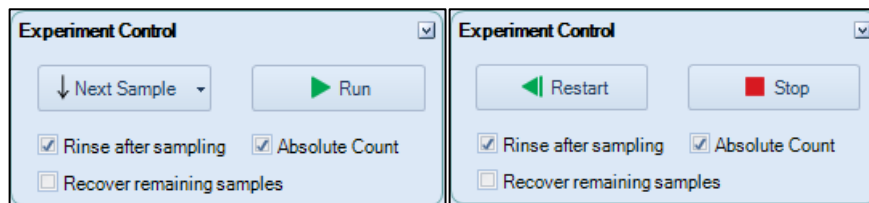

Figure 47. Experiment Control Panel

### NOTE

The sample injection probe may perform multiple aspirations for one sampling. Do not remove or change the test tube until the entire sampling process has completed.

### Note

When **Recover Remaining Samples** is checked, the remaining unused samples will be automatically returned to the sample tube. Please refer to [Experiment Control](#) in [NovoExpress Software Guide](#) for more details on this function.

During the acquisition, the **Cytometer Control > Active Sample Information** panel will show the progress in real-time, as shown in Figure 48.

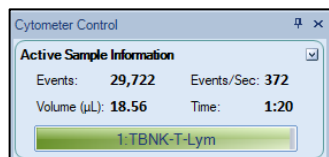

Figure 48. Active Sample Information

Once the stop condition is reached, sample acquisition will automatically stop.

### NOTE

You can also manually stop the sample acquisition by clicking the **Stop** button in the **Cytometer Control > Experiment Control** panel, during the sample acquisition process.

After sample acquisition is completed, the NovoCyte Quanteon flow cytometer automatically executes the cleaning process for the fluidics system and the sample injection probe. This helps to reduce cross-contamination between different samples. When the cleaning process is completed, repeat the above procedure for sample **NBK**.

### NOTE

If you want to increase the sampling speed, you can turn off the automatic cleaning procedure after sampling. To do so, uncheck **Rinse after Sampling** box in the **Cytometer Control** panel from the NovoExpress software as shown in Figure 47.

## Running Samples

### NOTE

Using templates helps to quickly copy the experiment settings or data analysis method of one sample and apply them to the other samples. For example, you can quickly copy the **T-Lym** experiment settings to sample **NKB** by dragging the **Cytometer Setting** under the **T-Lym** sample node and dropping it to sample **NKB** to apply the settings. For detailed information about the template function, please refer to the [NovoExpress Software Guide](#).

### CAUTION

**During sampling, do not obstruct the moving SIP. Do not place your hand on the sample tube.**

### CAUTION

**Before collecting samples, make sure the tube cap is removed from the sample tube. Failure to do so may cause severe damage of the sample injection probe.**

### WARNING



**Biological samples may be biohazardous. Appropriate personal protective equipment should be worn when handling the waste, which should be disposed of in accordance with local safety regulations.**

## Perform Fluorescence Compensation

Fluorescent molecules have their own spectral emission ranges, and it is possible that the emission spectra of two fluorescent molecules are overlapped in a certain wavelength range. This phenomenon is called Spectral Overlap and will cause one detector designated for detection of one fluorescent molecule to also detect signals from another fluorescent molecule. Fluorescence compensation refers to the process of correcting such spectral overlap, i.e. removing the interference of other fluorescent signals from the desired signals. The NovoExpress software offers three fluorescence compensation methods. The user can select the appropriate method according to their needs, which makes fluorescence compensation flexible and convenient.

### Automatic Fluorescence Compensation

Automatic compensation will calculate the fluorescence compensation matrix by the NovoExpress software automatically based on the results of an unstained

## Running Samples

control sample and a series of single-stained samples. The compensation matrix can be generated either from samples acquired on NovoCyte Quanteon instrument or from data imported from FCS files. Please refer to [Automatic Fluorescence Compensation from Imported FCS Files](#) in this guide for instructions on generate compensation matrix from imported FCS files. The automatically generated compensation matrix can be applied to the multi-color stained samples to achieve correct fluorescence compensation.

### Standard Automatic Fluorescence Compensation Procedure

The procedure for standard automatic compensation is described in the following steps:

- Prepare samples for fluorescence compensation
- Set up automatic fluorescence compensation parameters
- Run samples for automatic fluorescence compensation
- Automatic calculation of compensation matrix
- Apply compensation matrix to experimental samples

#### 1 Prepare samples for fluorescence compensation

Prepare a set of single-stained samples (labeled with only one fluorophore for each sample). Single-stained sample can be generated from the same biological sample as the experimental sample, or compensation beads may be used. Compensation beads are microspheres with capturing agent on the surface. The capturing agent on the surface of the compensation beads can react with fluorescent-labeled antibodies used in the experiment. Each single-stained sample should have a negative and a positive population. If there is no negative population in the single-stained sample, an unstained sample needs to be prepared for correct automatic compensation.

#### 2 Set up Automatic Fluorescence Compensation Parameters

Click **Home > Auto Compensation** icon , or right-click the experiment file name in the **Experiment Manager** and select **New Auto Compensation ...** (Figure 49). **The New Auto Compensation** window will appear (Figure 50). In this window, you can set the method and parameters for automatic compensation. Calculation of the compensation matrix can be set based on either the **Height** or the **Area** parameter and based on comparison of the **Mean** or **Median** of the positive and negative populations. Select **Compensation Channels** based on the prepared **Unstained** sample and the single-stained samples accordingly.

For the example described in this guide, single-stained compensation beads with FITC, PE, PerCP and APC will be used for automatic compensation. In

## Running Samples

**Compensation Channel**, select **FITC**, **PE**, **PerCP**, and **APC**. Select **Compensation on Height** and select **Median** as **Parameter for Calculation** (Figure 50). Click the **OK** button and a new **Compensation Specimen** will appear in the **Experiment Manager** under the experiment file node. This **Compensation Specimen** contains a series of single-stained samples as selected in the **Compensation Channels** (Figure 51).

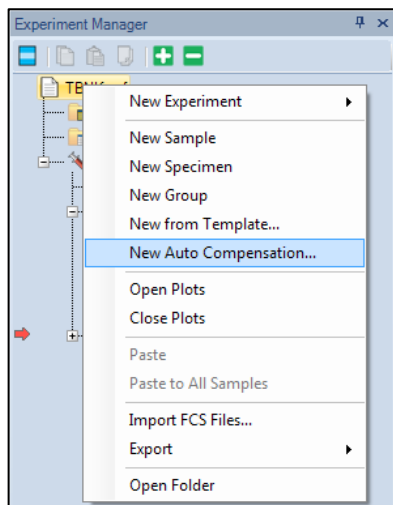

Figure 49. New Auto Compensation Menu

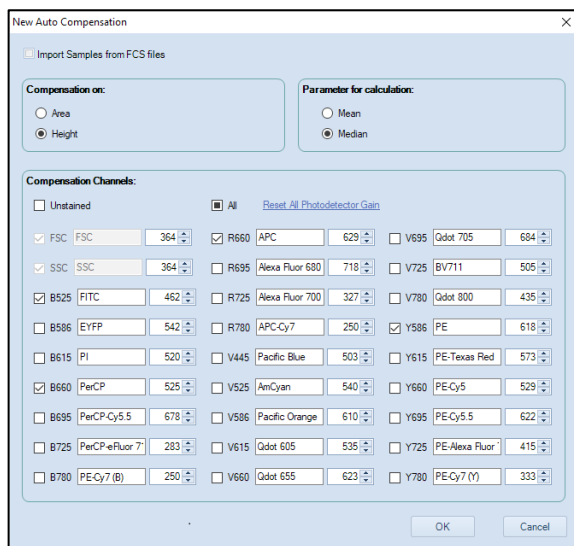

Figure 50. New Auto Compensation Window

## Running Samples

### NOTE

If you select the **Unstained** sample in the **Compensation Channel**, calculation of the compensation matrix will be based on the unstained sample, instead of the negative population in the single-stained sample.

### NOTE

The **Compensation Channels** shown in the **New Auto Compensation** window will be all the available channels based on the model of the NovoCyte Quanteon flow cytometer. The NovoExpress software automatically obtains such available channel information from the hardware. Correctly select the **Compensation Channels** to ensure the correct automatic compensation results. You can also change the settings by right-clicking the **Compensation Specimen** in the **Experiment Manager** (Figure 51) and select **Auto Compensation Setup ...**

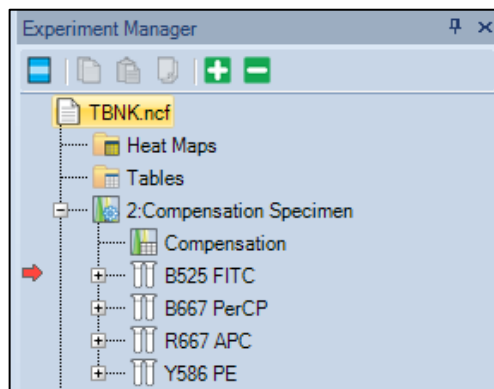

**Figure 51.** Compensation Specimen and Related Single-Stained Samples

### 3 Run Samples for Automatic Fluorescence Compensation

The default setting for acquiring automatic compensation samples are:

- Parameters: both Height and Area for all the available parameters
- Stop condition: total 10,000 events or 20 $\mu$ L sample volume.
- Sample flow rate: Slow
- Threshold: FSC-H larger than 100,000.

### NOTE

In order to ensure normal data acquisition and correct automatic fluorescence compensation, it is recommended to prepare the compensation sample concentration to be  $1 \times 10^6 \sim 2 \times 10^6$  /mL.

### NOTE

Most samples can be properly collected with the default settings. However, users can also change the settings accordingly.

## Running Samples

To collect the data, first double-click the sample to be collected in the **Experiment Manager** to make it the Active Sample. Then place the corresponding sample tube into the sample holder and click **Run** button. Repeat the procedure until all the compensation samples are collected.

After all the samples are collected, the NovoExpress software will automatically generate an FSC/SSC density plot, a histogram and a series of two parameter density plots with the fluorescence channel of the fluorophore used to stain the sample as the X-axis parameter and each of the other fluorescence channels as the Y-axis parameter for each sample. In the FSC-H/SSC-H density plot, a gate named **Main** will be automatically created for the main compensation beads or cell populations and be applied to all rest plots. NovoExpress will also set a Bi-Range gate for the histogram to separate the negative (**Negative** gate) and positive (**Positive** gate) populations, as shown in Figure 52.

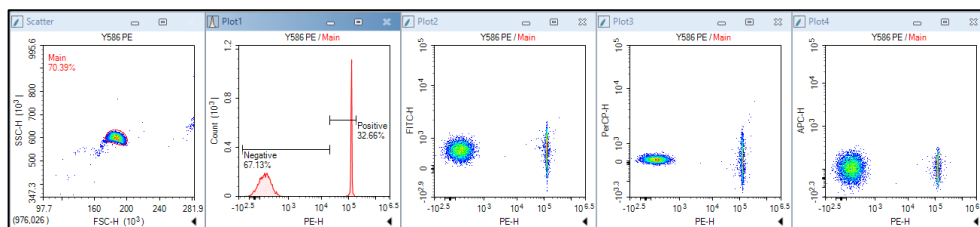

**Figure 52.** Data Analysis for PE Single-Stained Sample in Auto Compensation

Under normal circumstances, the automatically generated gates are appropriate. However, due to the complexity of the sample, in some cases, the automatic software gating algorithm may not be able to generate the optimal gates. Check the **Main**, **Negative**, and **Positive** gates to see if they are properly set. When necessary, adjust the gates manually to optimize the results.

### NOTE

If the single-stained sample does not have a negative population, be sure to always include an **unstained** sample for automatic compensation. Otherwise, the NovoExpress software cannot conduct automatic compensation and an error message will be generated.

### NOTE

User may need manually adjust the gates when significant amount of debris or complex populations are observed for single-stained sample.

## 4 Automatic Calculation of Compensation Matrix

The NovoExpress software will automatically calculate the compensation matrix based on the signals (Mean or Median) of the negative and positive populations. The font color of **Compensation** under the **Compensation Specimen** node in the **Experiment Manager** turns blue to indicate the compensation matrix has non-zero

## Running Samples

values (Figure 53). You can then view the **Compensation Matrix** (Figure 54) and **Spillover Matrix** (Figure 55) by double-clicking **Compensation** under the **Compensation Specimen** node in the **Experiment Manager**.

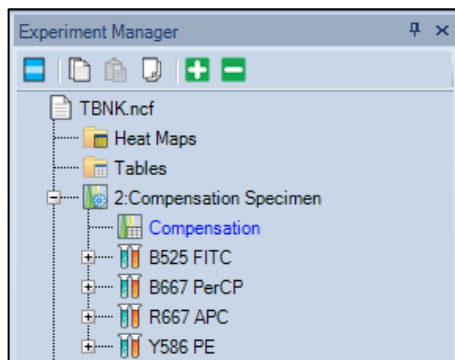

**Figure 53.** Double-click **Compensation** to View the Compensation Matrix

Compensation for Compensation Specimen				
Compensation Matrix		Spillover Matrix		
Source\Target	FITC	PerCP	APC	PE
FITC	-100.1024	0.8604	-0.157	0.0211
PerCP	11.9	-100.8524	18.5798	1.5362
APC	0.1507	3.4073	-100.6277	0.0736
PE	1.7087	7.8641	-1.448	-100.1207

**Figure 54.** Compensation Matrix Generated by Auto Compensation

Compensation for Compensation Specimen				
Compensation Matrix		Spillover Matrix		
Source\Target	FITC	PerCP	APC	PE
FITC	100	0.8558	0.0015	0.0342
PerCP	11.942	100	18.423	1.5504
APC	0.556	3.393	100	0.1257
PE	2.6366	7.8201	0.0008	100

**Figure 55.** Spillover Matrix Generated by Auto Compensation

### 5 Apply Compensation Matrix to Experimental Samples

There are two ways to apply the automatically generated compensation matrix to the experimental samples. The first method is to copy and paste the

## Running Samples

compensation matrix. Right-click **Compensation** under the **Compensation Specimen** node in the **Experiment Manager** and select **Copy**, as shown in Figure 56, then right-click the experimental sample in the **Experiment Manager** and select **Paste**. The second method is to treat the compensation matrix as a template. Select **Compensation** under the **Compensation Specimen** node, drag and drop it to the experimental sample to which you want to apply the compensation matrix. For detailed information about the template function, please refer to the [NovoExpress Software Guide](#).

### NOTE

You can also use the same method to apply the compensation matrix to a specimen. In this case, the same compensation matrix will be applied to all samples belonging to the specimen.

Once the compensation matrix is applied to the experimental sample, double-check the data after compensation and confirm the correctness of the compensation.

### NOTE

The compensation matrix generated by automatic compensation cannot be modified. However, after it is applied to the experimental samples, you can adjust the compensation matrix or spillover matrix if needed.

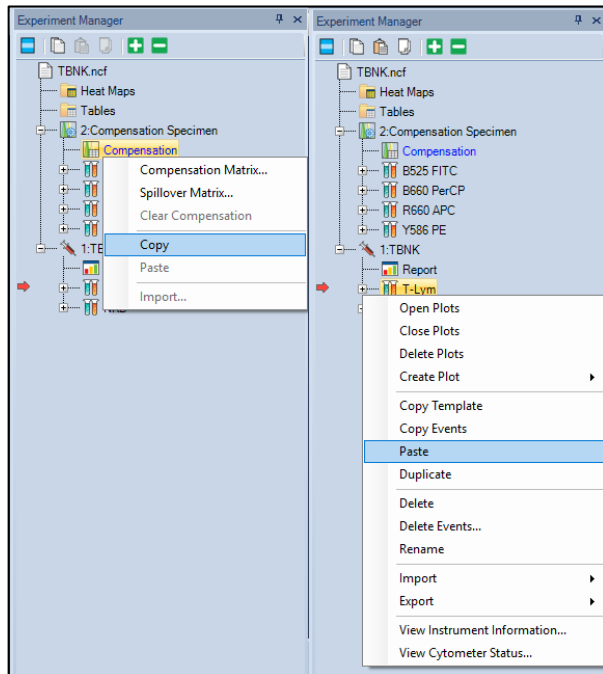

Figure 56. Copy/Paste the Compensation Matrix



## Running Samples

### Automatic Fluorescence Compensation from Imported FCS Files

To perform auto-compensation directly from the imported FCS file:

- 1 Click **Home > Auto Compensation** to open the **New Auto Compensation** window. Select **Import Samples from FCS files**.

#### NOTE

This window can also be accessed by right clicking the experiment file and selecting **New Auto Compensation** in the **Experiment Manager** window.

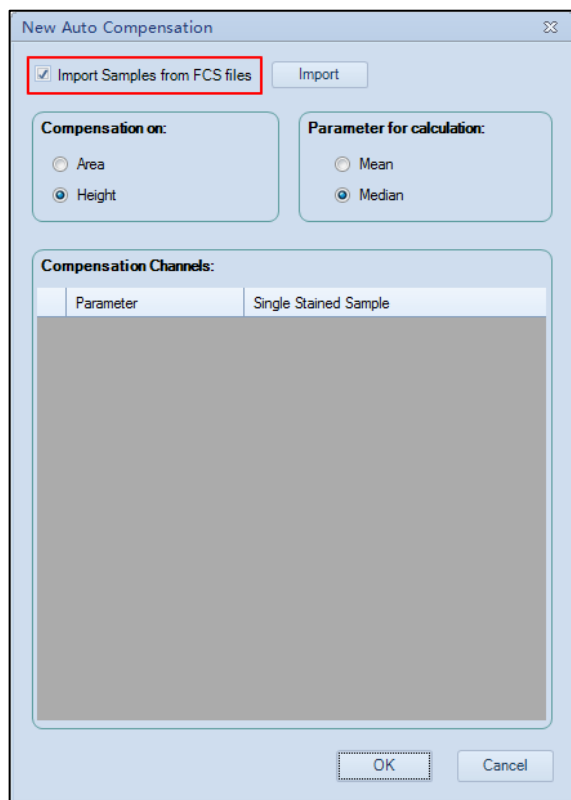

**Figure 57.** Open the New Autocompensation Window

- 2 Select the single file or multiple files while holding the **Shift** key in the keyboard. Click **Open** to import the selected file(s) to the software.

## Running Samples

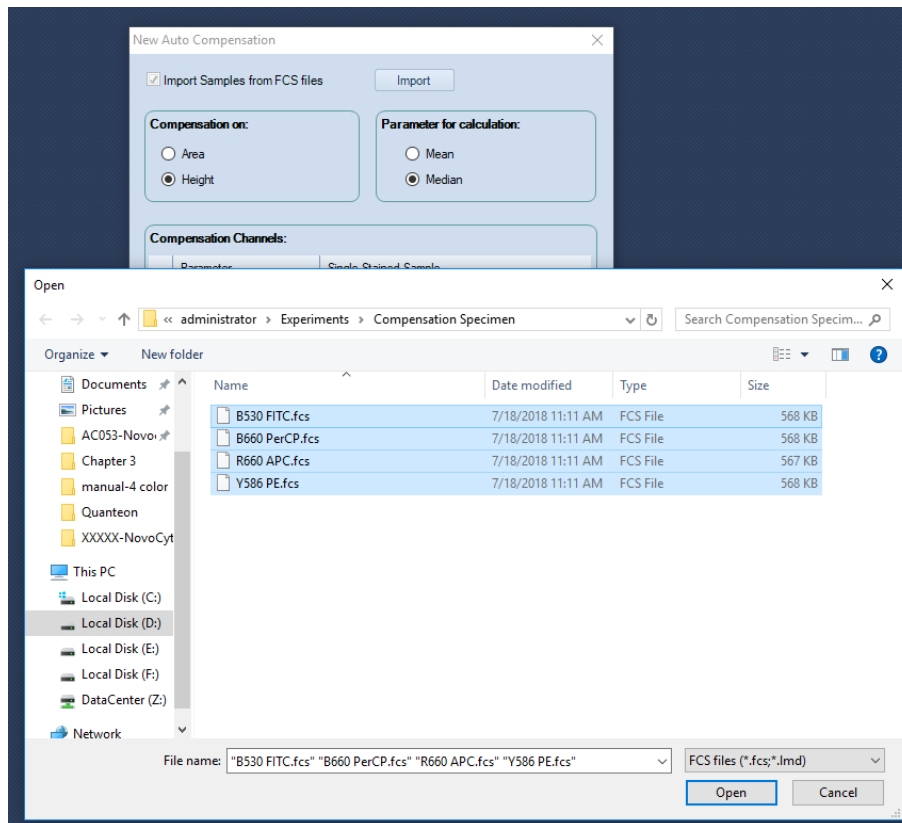

**Figure 58.** Import Samples from FCS Files

- 3 Ensure all the selected FCS files are successfully imported to the software. Click **OK** to continue.

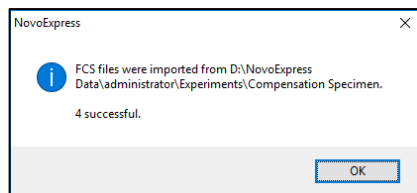

**Figure 59.** Dialog Box for Successful Importing FCS Files

- 4 Set the compensation parameters in the **New Auto Compensation** window (i.e. **Area** or **Height**, **Median** or **Mean**). Ensure the correct channel parameter is selected for each single stained sample. To select different single stained sample file, click the file name, select the desired file from the pull-down menu.

## Running Samples

If a channel parameter does not need to be included for the compensation, click the blank area in the pull-down menu. The check box in front of the corresponding channel parameter will be automatically unselected.

### NOTE

The software will automatically associate the imported FCS file with the selected channel parameter based on the keyword of the file name (e.g. B525). Users need to verify and select the correct FCS file for each fluorescence detection channel.

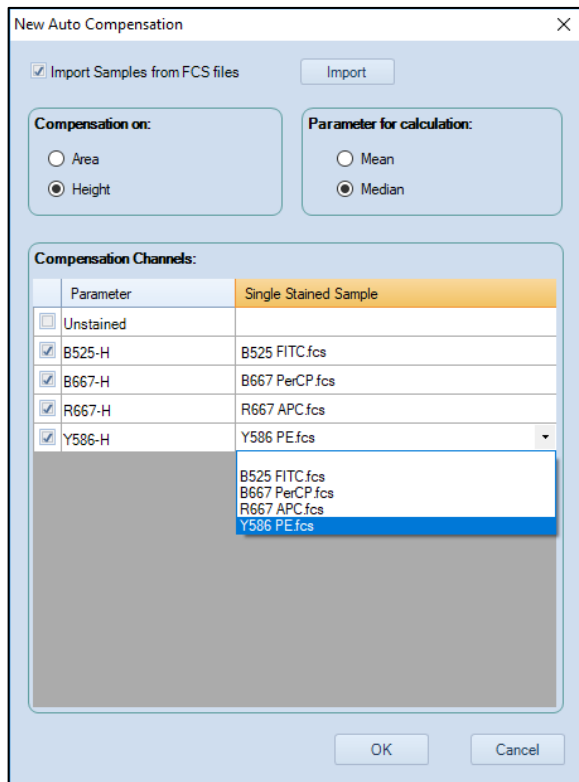

**Figure 60.** Set the Autocompensation Parameters

- 5 Click **OK** and NovoExpress will automatically calculate the compensation matrix based on the samples imported. Once generated, the compensation matrix can be applied to other experiment samples.

## Running Samples

### Manual Fluorescence Compensation

In addition to automatic fluorescence compensation, users can manually adjust the spillover matrix for fluorescence compensation. Similarly, a series of unstained and single-stained samples are needed.

Manual compensation could be done using the following procedure:

- Prepare samples for compensation
- Run compensation samples
- Edit the compensation matrix
- Apply the compensation matrix

### Prepare Samples for Compensation

Use the same method to prepare the unstained and single-stained samples as described for automatic compensation.

### Run Compensation Samples

Use the method described in the previous sections to collect the data for all the compensation samples.

### Edit Compensation Matrix

Create an FSC/SSC density plot and set a gate for the main population on the plot. Then create a density plot with the fluorescence channel of the fluorophore used to stain the sample as the X-axis parameter and each of the other fluorescence channels as the Y-axis parameter. Apply the main population gate to all the fluorescence channel density plots.

For example in this guide, for the PE single-stained compensation beads, a gate named Main is created for the main beads' population on the FSC/SSC plot. Create a PE/FITC, a PE/PerCP and a PE/APC density plot and apply the Main gate to all the plots. For the PE/FITC density plot, adjust the spillover matrix coefficient to subtract the PE signal from the FITC signal (i.e. FITC – % PE) to compensate for the PE spillover into the FITC channel. The criterion for correct compensation is to make the Mean or Median value of the PE positive population and negative population to match each other as closely as possible on the FITC channel. The same method and principle apply to compensation of PE spillover into the PerCP channel on the PE/PerCP plot and PE spillover into the APC channel on the PE/APC plot. Similarly, for the FITC, PerCP and APC single-stained samples, follow the same procedure to subtract the corresponding fluorescence spillover into the other detection channels.

## Running Samples

There are three methods to edit the spillover matrix coefficient. One is by clicking the **Quick Compensation** icon and moving the slide bar on the corresponding fluorescence channel density plot directly (Figure 61). Another method is by clicking **Home** > **Compensation Matrix** to load the compensation editing window. The third method is by right-clicking the **Compensation** under the corresponding sample node in the **Experiment Manager** and selecting **Spillover Matrix ...** to load the compensation editing window.

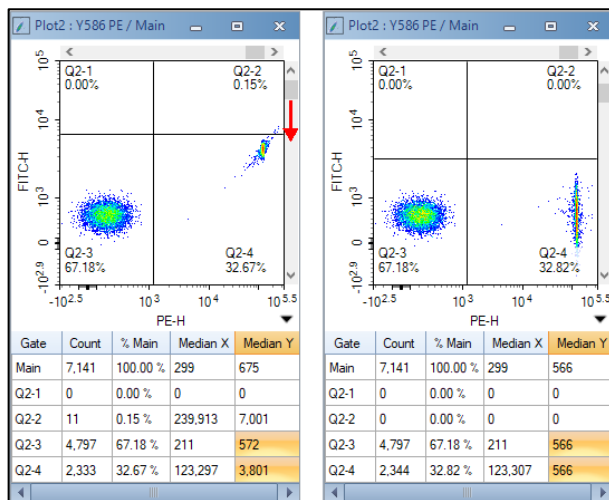

**Figure 61.** Quick Compensation

A quadrant gate helps to judge if the correct compensation has been achieved. For example, in PE/FITC density plot, draw a quadrant plot to divide the plot into four segments. Include the PE negative population in the bottom-left segment and the PE positive population in the bottom-right segment. Use the quick compensation sliding bar or adjust the coefficient in the spillover matrix to conduct the compensation. The correct compensation is achieved when the Mean or Median of the FITC signal for the PE positive population and PE negative population is the same or is very similar. The coefficient in the spillover matrix directly indicates the percentage of PE signal spillover into FITC channel. Click the corresponding coefficient in the spillover matrix, the information will be shown in the bottom-left of the spillover matrix indicating a certain percentage of one fluorescence signal (fluorophore in the corresponding column) need to be subtracted from the other fluorescence signal (fluorophore in the corresponding row), as shown in Figure 62. In the same way, compensate the PE spillover into the PerCP and APC channels on the PE/PerCP and PE/APC density plots. Compensation for PE signal is then completed, and results are shown in Figure 63. The spillover matrix for PE single-stained sample is shown in Figure 62.

## Running Samples

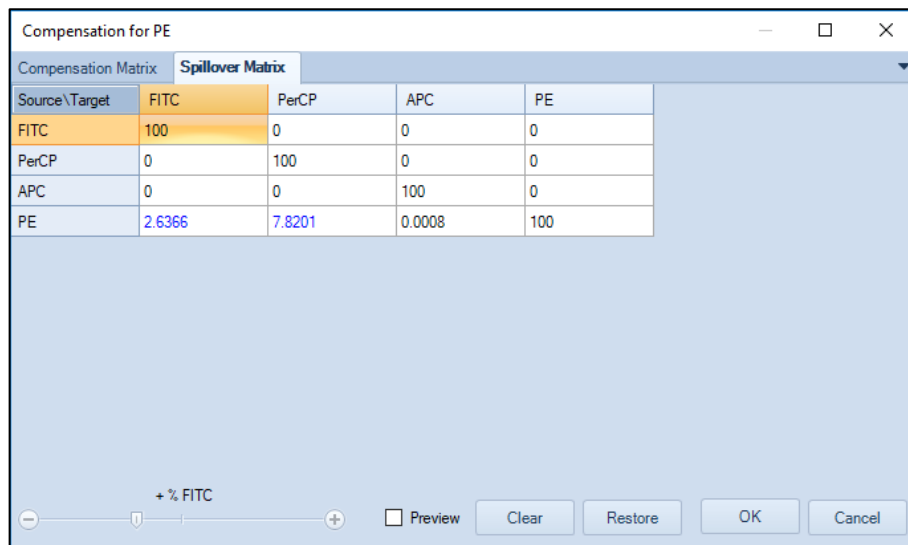

**Figure 62.** Compensate FITC Spillover into PE Channel in Spillover Matrix

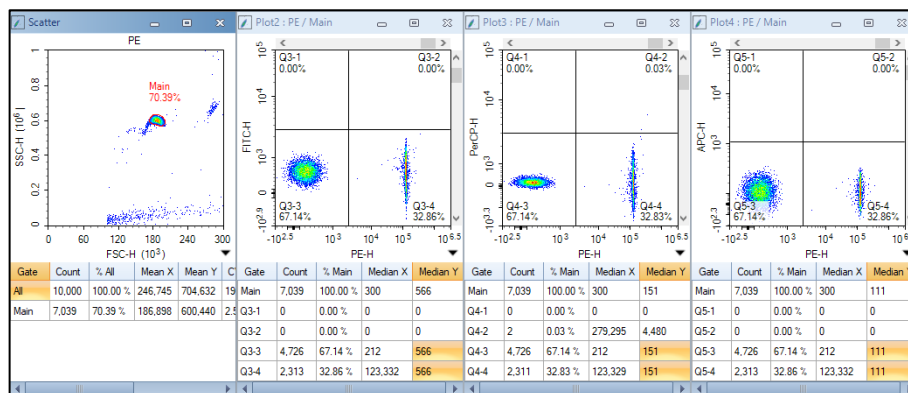

**Figure 63.** Compensate PE Spillover into FITC, PerCP and APC Channels

### NOTE

Select **Preview** in the compensation window to visualize the compensation results dynamically when adjusting the spillover matrix coefficient. Click the **Expand Statistics** icon  in the bottom-right corner of the plot to show the statistical calculation results. Look at the corresponding Mean or Median value to judge if the correct compensation has been achieved.

## Running Samples

Repeat the same procedure for the FITC, PerCP and APC single-stained samples and the corresponding spillover matrices are shown in Figure 64, Figure 65, and Figure 66, respectively.

Compensation for FITC				
Compensation Matrix		Spillover Matrix		
Source\Target	FITC	PerCP	APC	PE
FITC	100	0.8558	0.0015	0.0342
PerCP	0	100	0	0
APC	0	0	100	0
PE	0	0	0	100

**Figure 64.** Spillover Matrix for FITC Single-Stained Sample

Compensation for PerCP				
Compensation Matrix		Spillover Matrix		
Source\Target	FITC	PerCP	APC	PE
FITC	100	0	0	0
PerCP	11.942	100	18.423	1.5504
APC	0	0	100	0
PE	0	0	0	100

**Figure 65.** Spillover Matrix for PerCP Single-Stained Sample

Compensation for APC				
Compensation Matrix		Spillover Matrix		
Source\Target	FITC	PerCP	APC	PE
FITC	100	0	0	0
PerCP	0	100	0	0
APC	0.556	3.393	100	0.1257
PE	0	0	0	100

**Figure 66.** Spillover Matrix for APC Single-Stained Sample

### Apply the Compensation Matrix

To use the compensation coefficient generated by the single-stained samples, manually input the corresponding coefficient from each single-stained sample into the spillover matrix of the experimental sample (Figure 67). Check to make sure the compensation has been applied to the experimental sample and confirm the correctness of the compensation. This compensation matrix can then be used as

## Running Samples

a template and may be applied to the other experimental samples. Figure 68 and Figure 69 shows the results of the **T-Lym** sample before and after the compensation, respectively.

Compensation for Sample1				
Compensation Matrix		Spillover Matrix		
Source\Target	FITC	PerCP	APC	PE
FITC	100	0.8558	0.0015	0.0342
PerCP	11.942	100	18.423	1.5504
APC	0.556	3.393	100	0.1257
PE	2.6366	7.8201	0.0008	100

**Figure 67.** Incorporate the Spillover Coefficients from Single-Stained Samples into the Spillover Matrix

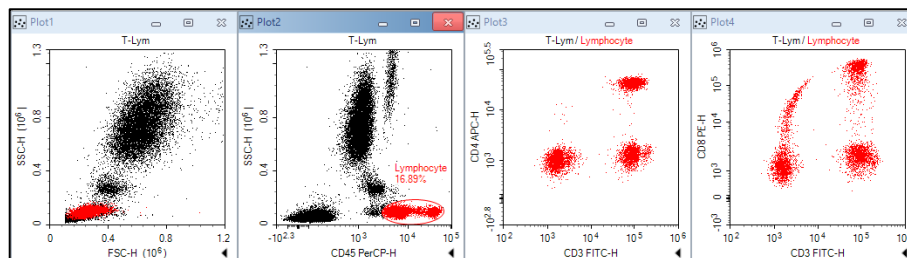

**Figure 68.** Results of T-Lym Sample: Before Compensation

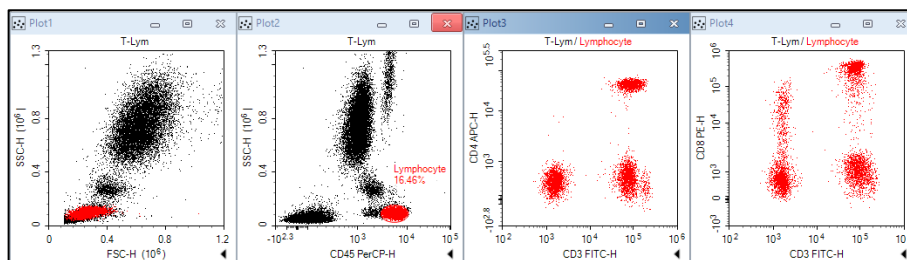

**Figure 69.** Results of T-Lym Sample: After Compensation

### NOTE

Please refer to [NovoExpress Software Guide](#) for details about the compensation functions.



## Running Samples















### NOTE

The fluorescence signal may become negative after compensation, which is problematic to display using a logarithmic scale. To address this issue, the NovoExpress software provides a Bi-Exponential Transform for data scaling. Right-click the axes on the density plot and select **Biexponential** as the plotting scale. Please refer to the [NovoExpress Software Guide](#) for details about the biexponential transform.

### NOTE

The biexponential scale will take more computer resources for plotting and thus may lead to slower refreshing speed for the displayed data, especially when the number of the events is large. When this occurs, using the logarithmic scale may help to improve the data refreshing speed during the compensation process. After the compensation adjustment is done, switch back to biexponential scale to have a better visualization of the data.

## Analyze Data

The NovoExpress software provides a variety of plots and gates for flow cytometry data analysis. The type of plots includes dot plot , density plot , histogram , contour plot , cell cycle analysis plot , cell proliferation plot , and bi-variate plots . Gates include rectangular gate , elliptical gate , polygon gate , freehand gate , quadrant gate , logic gate , range gate , and bi-range gate . By clicking the icon in the NovoExpress software data analysis toolbar (Figure 70), you can create the corresponding plot and gate.



**Figure 70.** NovoExpress Software Data Analysis Toolbar

### NOTE

Please refer to [NovoExpress Software Guide](#) for details about plots and gates.

Data analysis can be conducted during or after the sample acquisition. In this guide, commonly used data analysis methods and procedures will be described using the CD3 FITC/CD8 PE/CD45 PerCP/CD4 APC stained human peripheral blood sample as an example. The general methods apply to the other data analysis as well.

- Set Sample as Active Sample

## Running Samples

In the **Experiment Manager**, double-click the sample to be analyzed to make the sample the Active Sample. A red arrow at the left of the sample indicates this sample is the Active Sample.

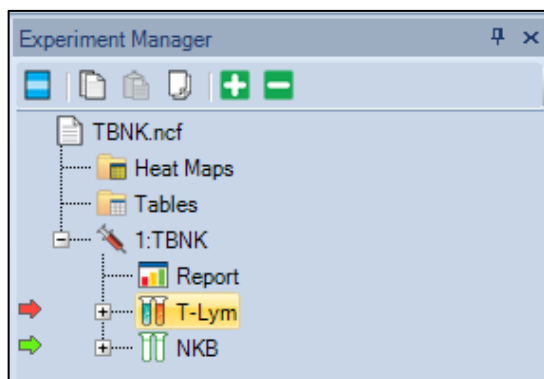

### NOTE

Data analysis can be conducted when the sample acquisition is in process. In this case, a green flashing arrow will show at the left of the sample currently acquiring data. For example, in Figure 71, sample **T-Lym** is the Active Sample for data analysis, while sample **NKB** is currently acquiring data.

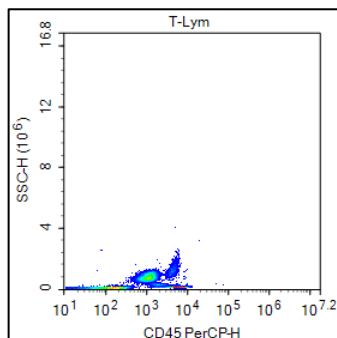

**Figure 71.** Active Sample in Data Analysis (Red Arrow) and Sample in Data Acquisition (Green Arrow)



- Create Plots and Gates

Firstly, we need to look at the CD45 PerCP vs. SSC plot to locate the target cell population, i.e. the lymphocytes, which have relatively large PerCP signal but small SSC signal. In order to create the CD45 PerCP vs. SSC plot, click the dot plot icon  or the density plot icon  from the data analysis toolbar. The sample name will show at the top of the plot. The default parameters for a new dot plot or a new density plot is always FSC Height (FSC-H) as the X-axis parameter and SSC Height (SSC-H) as the Y-axis parameter. In this example, the X-axis needs to be changed to be **CD45 PerCP-H**. To do so, right-click the **FSC-H** on the plot and select **Height > CD45 PerCP-H** from the drop-down list. The X-axis parameter will change to **CD45 PerCP-H** accordingly (Figure 72).

## Running Samples



**Figure 72.** CD45 PerCP-H/SSC-H Density Plot

The NovoCyte Quanteon flow cytometer has a very large dynamic range (0 to  $2^{24}=16,777,216$ ), so the data will often only occupy a small area of the plot when using the full-scale axes. Zoom-in to enlarge the data area of interest. To zoom in, click the zoom-in icon  from the data analysis toolbar, or right-click on the selected plot and select **Zoom In** from the drop-down list. Move the mouse across a rectangular area to zoom in the population of interest. Upon release of the mouse button, the range of the plot is automatically enlarged according to the zoom-in operation. You can also Undo the Zoom In operation by clicking the undo icon  or click the zoom-out icon  from the toolbar. Repeat the above steps until the data of interest is properly shown on the plot as shown in Figure 73.

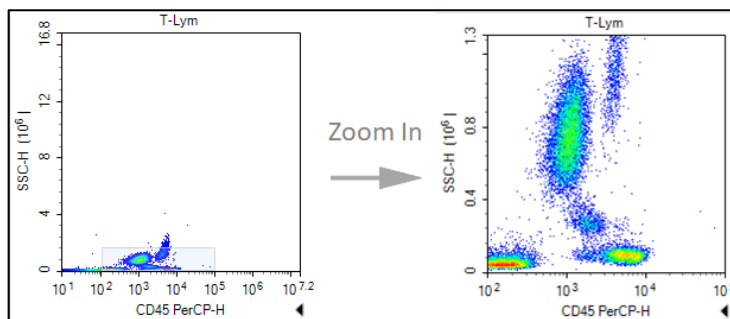

**Figure 73.** Zooming in the Density Plot

- Create a Gate for Lymphocytes

Click the elliptical gate icon , draw an elliptical gate to include the lymphocyte population (large PerCP signal and small SSC signal) on the CD45 PerCP-H/SSC-H density plot. The default name of the gate is E1 (E indicates an elliptical gate). Click the E1 gate label and use the keyboard to change the name of the gate to **Lymphocyte**.

- Create a CD3 FITC-H/CD8 PE-H and a CD3 FITC-H/CD4 APC-H Dot Plot

## Running Samples

Click the dot plot icon  twice to create two new dot plots. Change the X-axis parameter to be CD3 FITC-H and the Y-axis to be CD8 PE-H for the first dot plot. Change the X-axis parameter to be CD3 FITC-H and Y-axis to be CD4 APC-H for the second dot plot. Right-click the name of both plots and select **Lymphocyte** from the list to apply the **Lymphocyte** gate (created in CD45 PerCP-H/SSC-H density plot) to both plots. Observe the change after application of the gate.

- Compensate the Sample

Use the method described in [Perform Fluorescence Compensation](#) in this guide to apply the compensation matrix created by either automatic compensation or manual compensation to the sample. Figure 68 and Figure 69 show the data for the **T-Lym** sample before and after compensation.

- Statistics

In the CD3 FITC-H/CD8 PE-H and CD3 FITC-H/CD4 APC-H dot plots, create a quadrant gate to isolate the positive and negative cell populations. Click the small triangle at the bottom-right of the plot to expand the statistical results of the data, as shown in Figure 74. Right-click any place on the statistical table to select additional statistical parameters to be calculated for the data, as shown in Figure 75.

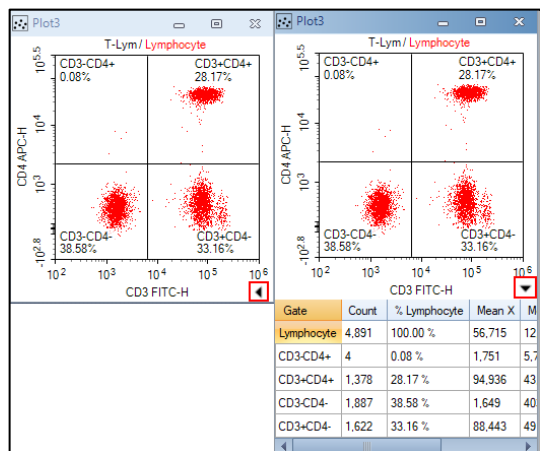

Figure 74. Statistical Data

## Running Samples

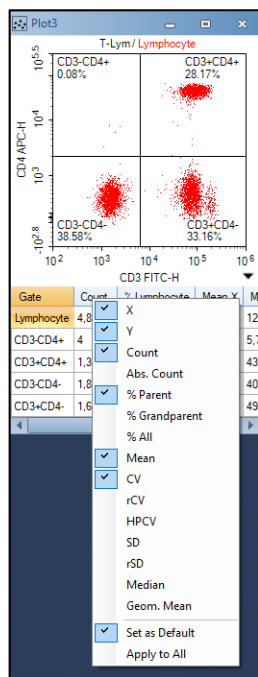

Figure 75. Select other Statistical Parameters

### NOTE

For details about statistics, please refer to the [NovoExpress Software Guide](#).

## Append Data

Additional data can be acquired for samples which already include data. Newly acquired data will be appended to the existing data for the sample.

- 1 Select the sample to be the Active Sample. Set the **Stop Condition** for the acquisition.
- 2 Load the sample into the sample holder.
- 3 Click **Run** button in the **Cytometer Control** panel. If the sample already contains data, a dialog box will pop up. Click the **Append** button to add more data to the sample. Click the **Overwrite** button to delete the existing data and re-collect the data.

# Delete Data

You can delete all the data or specify a portion of the data to be deleted. Right-click the sample in the **Experiment Manager** and select **Delete Events**. A window will pop up as shown in Figure 76. Select **All** to delete all the events from the sample, or only delete events **Outside** or **Inside** a specified gate.

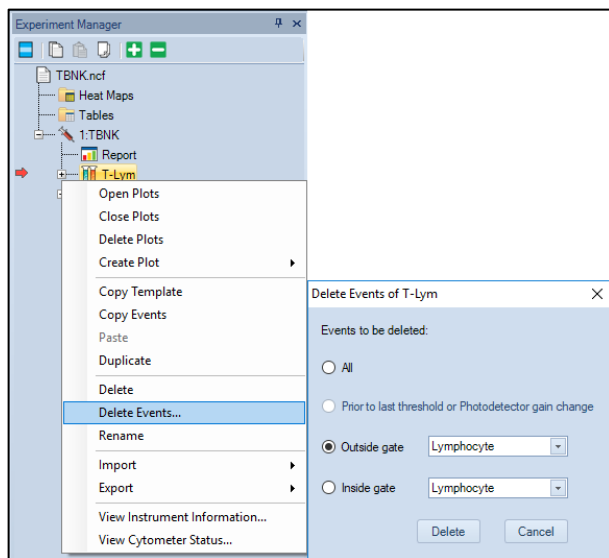



Figure 76. Delete Events

# Save Data

The NovoExpress software automatically saves the data, along with the cytometer settings information, to the experiment file. However, data analysis, including all the plots and gates, fluorescence compensation, created Reports and Statistical Tables, etc., must be saved manually. To save, click **File > Save** from the menu or click the **Save** icon . Otherwise, when closing the NovoExpress software, a message will prompt to remind users about saving the data.

# Import and Export Files

The .ncf data file includes all the acquired data, information about cytometer settings and data analysis, etc. The data can also be exported as an FCS 3.0, FCS 3.1, or CSV file and be analyzed by a third-party software. There are two methods to export a file.

- To manually export a file, right-click the specimen or sample name in the **Experiment Manager** and select **Export > Export FCS File ...** or **Export > Export CSV File ...**, as shown in Figure 77. In the prompt window, specify the folder to export the data.

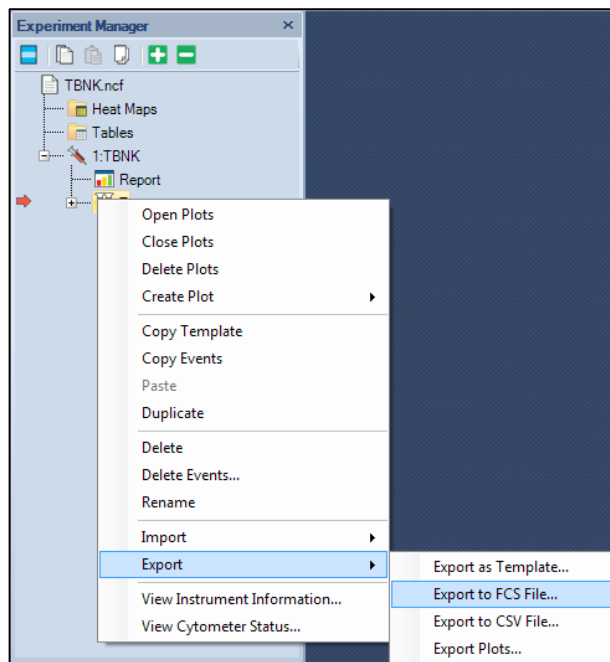

**Figure 77.** Manually Export Data

The data can be automatically exported once the data acquisition is completed. To do so, click **Setting > Option > Experiment** in the software main window. Select the check box for **Automatically export samples to FCS/CSV files after data acquisition completed** to enable this function (Figure 78). Once enabled, click **Export Setting** to open the **Export Events** window. Export settings, including generated file format (i.e. FCS 3.0, FCS3.1 or CSV), can be defined in this window (Figure 79).

## Running Samples

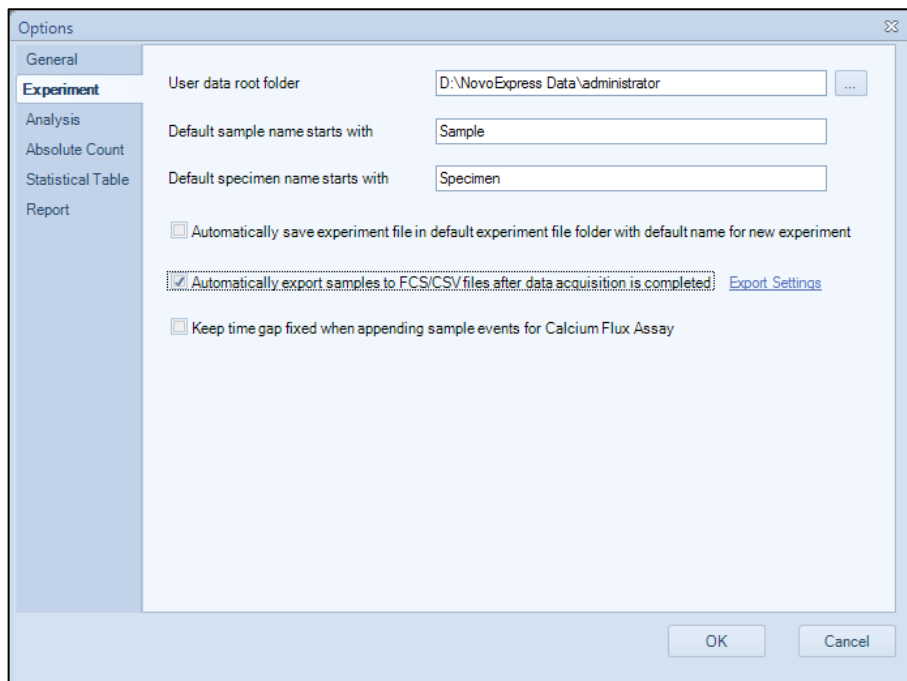

**Figure 78.** Enable the Automatic Data-Exporting Function

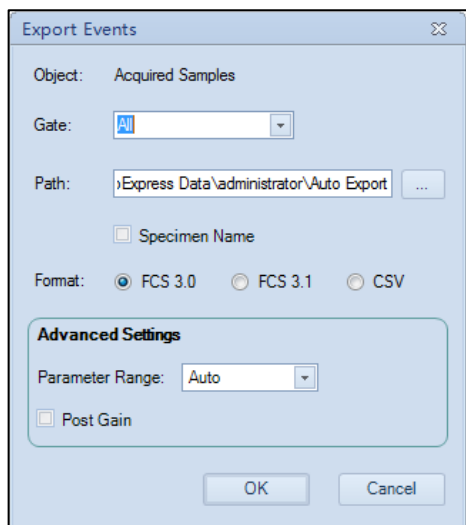
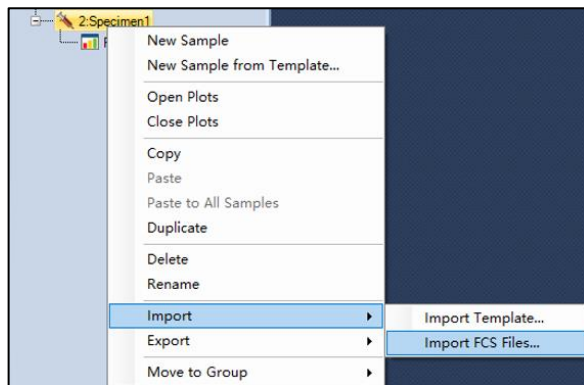

**Figure 79.** Configure Exporting Settings



## Running Samples

FCS 2.0, FCS 3.0 and FCS 3.1 format files may also be imported into NovoExpress for viewing and analysis. To import the FCS file, create a blank sample or specimen in the **Experiment Manager**, right-click and select **Import > Import FCS File ...**, as shown in Figure 80.



**Figure 80.** Import FCS File

### NOTE

The NovoExpress software provides powerful data analysis functions, such as data analysis templates, batch report, statistical tables, cell cycle analysis, cell proliferation analysis etc. For details about the data analysis function of NovoExpress software, please refer to the [NovoExpress Software Guide](#).

## Running Samples

This page is intentionally left blank.

## 6 System Maintenance

This chapter describes the procedures to maintain NovoCyte Quanteon flow cytometer, including scheduled and unscheduled maintenance.

It is important to conduct the instrument maintenance on a regular basis in order to achieve the optimal performance for the instrument and obtain reliable data. Agilent flow cytometer incorporates automatic procedures for maintenances as much as possible in order to bring conveniences to the users and save them valuable time. Most maintenance procedures will be automatically executed, eliminating the time-consuming manual maintenances.

### Scheduled Maintenance

The following maintenance should be conducted on regular basis.

**Table 9 Scheduled Maintenance and Recommended Frequency**

Maintenance	Recommended Maintenance Frequency
Daily Start-up	Daily. Automatic system cleaning during start-up.
Daily Shutdown	Daily. Automatic system cleaning and decontamination during shutdown.
Add instrument reagents (NovoFlow sheath fluid, NovoRinse solution, and NovoClean solution)	As needed. Check the instrument reagent volume in the containers before each experiment and add more reagents when necessary.
Empty Waste	As needed. Check waste volume before each experiment and empty waste container when necessary.
Preventive Maintenance <ul style="list-style-type: none"><li>• Clean the sample injection probe (SIP)</li><li>• Clean the SIP cleaning apparatus</li><li>• Unclog the flow cell</li><li>• Sterilize instrument reagent containers</li></ul>	Every month.

## System Maintenance

**Table 9 Scheduled Maintenance and Recommended Frequency**

Replacing Fluidic System Consumables	Every two months or when prompted by NovoExpress Software.
Replace 0.05 µm Sheath Fluid Ultrafiltration (UF) Filter (Optional)	Every two weeks

### Preventative Maintenance

It is recommended to conduct preventative maintenance once every month to ensure the fluidic system is in optimal condition.

#### Clean the Sample Injection Probe (SIP)

If the outer surface of the sample injection probe is dirty, follow the procedure below to manually clean the outer surface of the sample injection probe.

#### NOTE

The procedures described below may vary if NovoSampler Q is used. Please refer to [NovoSampler Q Operator's Guide](#) for more details.

- 1 Ensure the instrument is powered on and NovoExpress software is launched.
- 2 Click **Instrument > Shut Down** on the NovoExpress software.
- 3 Select **Clean sample injection probe** option and then click **Yes** button in the prompted window. NovoExpress software will guide you to conduct the cleaning SIP procedure.

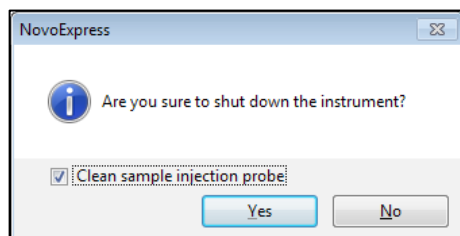

**Figure 81.** Message in NovoExpress Software when Shutting down

#### NOTE

The instrument will shut down directly if **Clean sample injection probe** option is not selected.

- 4 Follow the instruction in the software to remove the sample tube from the tube holder.

## System Maintenance

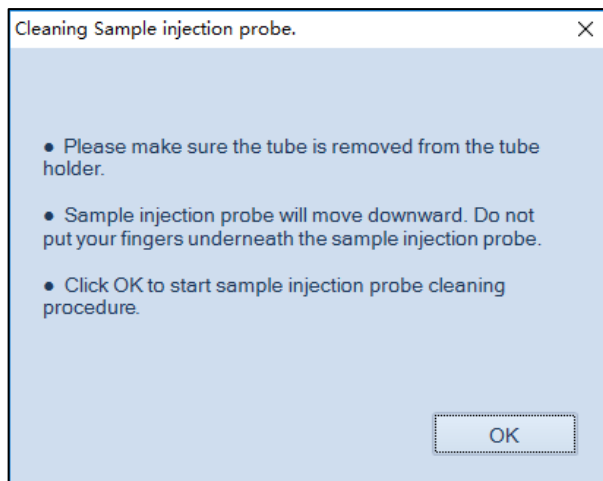

Figure 82. Software Message Instructing to Remove Sample Tube

### WARNING

**Sample injection probe will move downward after clicking the OK button. Do not put your fingers underneath the sample injection probe!**

- 5 Prepare a cotton swab or a damp soft cloth with NovoClean solution (1X) and gently wipe the outer surface of the sample injection probe.

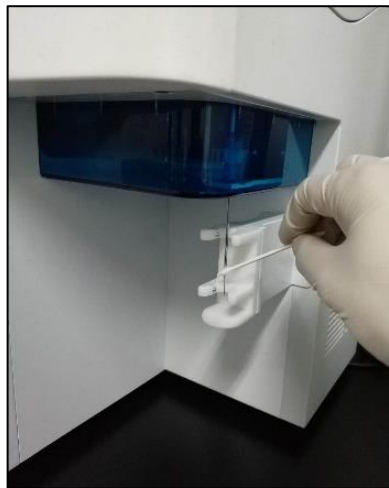

Figure 83. Wipe the Outer Surface of the Sample Injection Probe

## System Maintenance

### WARNING



Sample injection probe directly contacts the biological samples which may be biohazardous. Wear gloves when handling the sample injection probe.

### CAUTION

Sample injection probe is fragile and may be damaged if handled improperly. When cleaning the sample injection probe, please be careful not to deform or bend it.

- 6 Click **OK** button after cleaning.

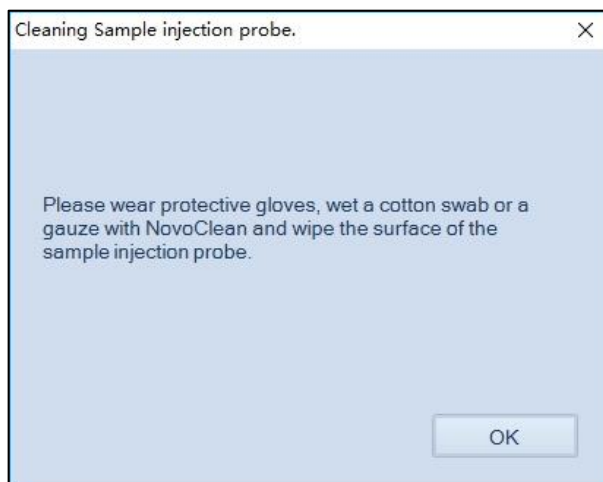

**Figure 84.** Software Message Instructing the Cleaning Procedures

- 7 Place a tube of Milli-Q or 0.2  $\mu\text{m}$  filtered DI water or NovoRinse solution (1X) in the tube holder. The instrument will shut down automatically after clicking **OK** button.

## System Maintenance

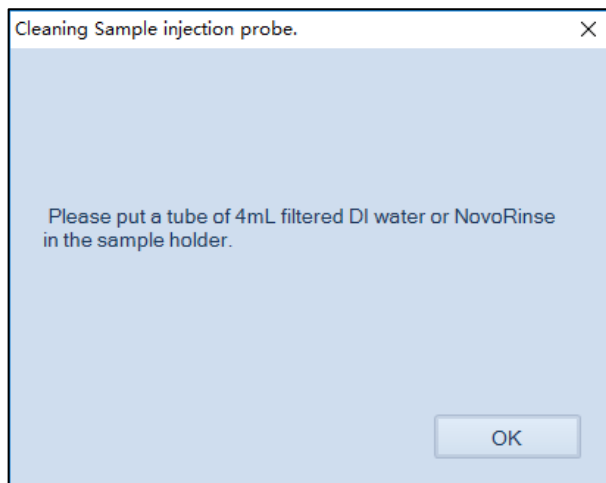

**Figure 85.** Software Message Instructing to Load a Sample Tube

### Clean the SIP Cleaning Apparatus

- 1 Turn off the power of the instrument.
- 2 Prepare a cotton swab soaked with NovoClean solution (1X). Wipe the SIP cleaning apparatus' lower surface back and forth until it is clean.



**Figure 86.** Wipe the SIP Cleaning Apparatus' Lower Surface

- 3 Prepare a damp cloth soaked with Milli-Q or 0.2  $\mu\text{m}$  filtered DI water. Wipe the SIP cleaning apparatus back and forth at least five times.

## System Maintenance

- 4 Power on the instrument and start NovoExpress software. After the instrument is **Ready**, click **Instrument > Fluidics Maintenance > Cleaning** to finish.

### WARNING



SIP cleaning apparatus directly contacts the biological samples which may be biohazardous. Wear gloves when handling the SIP cleaning apparatus.

### CAUTION

When cleaning the SIP cleaning apparatus, please be careful to prevent any damages to the apparatus and sample injection probe.

### Unclog the Flow Cell

When the instrument is in **Ready** status, click **Instrument > Fluidics Maintenance > Unclog** from NovoExpress software, and the **Unclog** procedure will automatically be executed. The progress of the procedure will be shown in the NovoExpress status bar.



Figure 87. Unclog Function in NovoExpress

### Sterilize Instrument Reagent Containers

It is very important to keep the instrument reagent free of contamination by sterilizing the instrument reagent containers. This procedure is highly recommended once a month or whenever there is a suspected bacteria growth or possible contamination (e.g. by mishandling the containers). The reagent containers need to be properly removed and sterilized using the following method respectively.

#### NOTE

Please refer to [Instrument Start-Up](#) in this guide for instruction on removing the containers.

#### NOTE

The procedures described below may vary if NovoCyte Fluidics Cart is used. Please refer to [NovoCyte Fluidics Cart Operator's Guide](#) for more details.

- 1 Ensure the container is properly removed from the fluidics station. Wipe the outer surface of the container using clean soft cloth soaked with 70% ethanol.
- 2 Empty the reagent container. Fill the NovoFlow container with at least 300 mL of NovoClean solution (1X) and cap the bottle. Fill the NovoClean and



## System Maintenance

NovoRinse container with at least 100 mL of NovoClean solution (1X) and cap the bottle. Shake the container vigorously to let the NovoClean solution cover the entire inner surface. Repeat for 3 times and then soak for 30 min.

- 3 Empty the reagent container again. Fill about 500 mL Milli-Q or 0.2 µm filtered DI water (or NovoFlow solution) to NovoFlow container and cap the bottle. Fill about 100 mL Milli-Q or 0.2 µm filtered DI water (or NovoFlow solution) to NovoClean and NovoRinse container and cap the bottle. Shake reagent container for at least 2 minutes.
- 4 Repeat Step 3 three times.
- 5 Fill the reagent container all the way to the neck or close to the brim with Milli-Q or 0.2 µm filtered DI water or NovoFlow sheath fluid. Soak for 20 min and empty the reagent container.
- 6 Wipe the outer surface of the container with a dry and clean soft cloth.
- 7 Place the container back onto the fluidics station.

## Replacing Fluidic System Consumables

NovoExpress software monitors the accumulated running time of the fluidic system consumables to ensure the consumables are changed in a timely manner for optimal flow cytometry results. When the accumulated running time is reached, the NovoExpress software will prompt a message to remind the user to replace the consumables (Figure 88). A similar message will be prompted when the last replacement is 60 days ago as shown in Figure 89.

Click **Replace** to continue. Clicking the **Close** button will cancel the process and allow continued use of the system. However, the consumables should be replaced promptly.

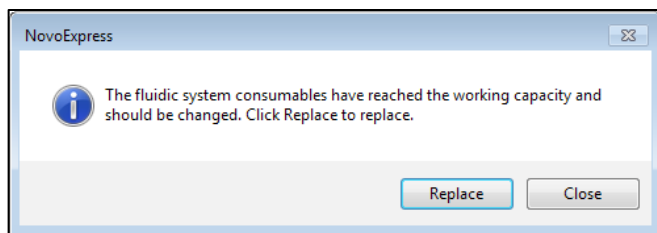

**Figure 88.** Software Message Indicating Fluidic System Consumables Reached Working Capacity

## System Maintenance

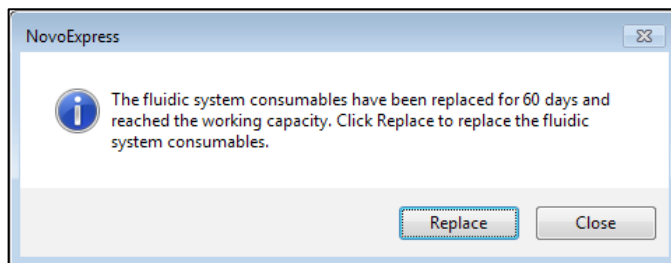

**Figure 89.** Software Message Indicating Last Replacement of Fluidic System Consumables is 60 Days Ago

### NOTE

The fluidic system consumable replacement process can also be initiated manually at any time by clicking the **Instrument > Replace Fluidic System Consumables** icon in the NovoExpress software when the instrument is in **Ready** status.



**Figure 90.** Replace Fluidic System Consumables icon

Click the **Replace** button and a dialog box is prompted in the window below.

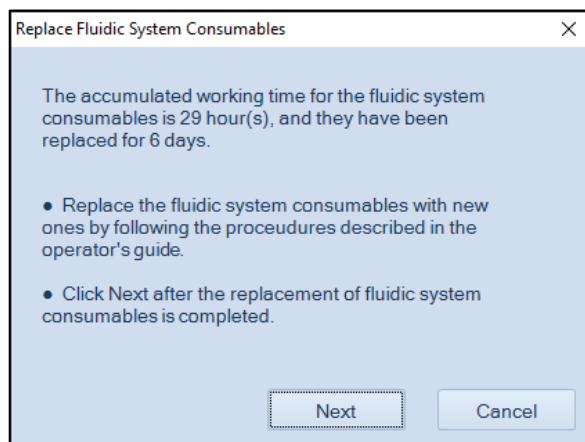

**Figure 91.** Software Message for Fluidics Consumables Replacement

The following fluidic system consumables should be replaced at the same time:

- NovoFlow sheath fluid in-line filter (1pcs)
- Waste filter (1pcs)

## System Maintenance

- NovoFlow sheath fluid inlet filter (1pcs)
- NovoRinse solution inlet filter (1pcs)
- NovoClean solution inlet filter (1pcs)

Follow the procedure described below to replace all the fluidic system consumables.

Once all the fluidic system consumables have been replaced with the new ones, click the **Next** button to continue.

If **Cancel** is selected, a dialog box below will be prompted. The process can be aborted by clicking **Yes** button.

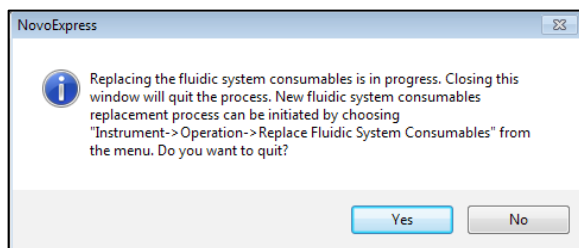

**Figure 92.** Software Message for Cancelling Fluidics System Consumable Replacement

A confirmation message as shown below will be prompted. Click **Yes** button to inform the system that the consumables have been replaced.

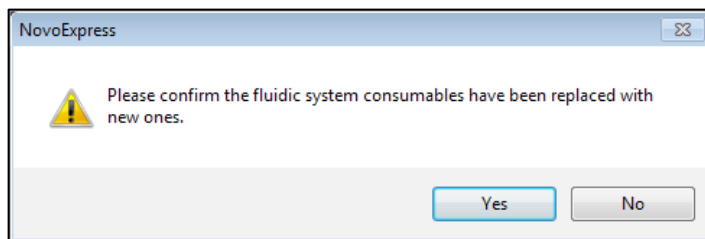

**Figure 93.** Software Message to Confirm the Fluidics Consumables are Replaced

After confirmation of fluidics consumables being replaced, the NovoExpress software will prompt a window to remind users to conduct the **Priming** procedure.

## System Maintenance

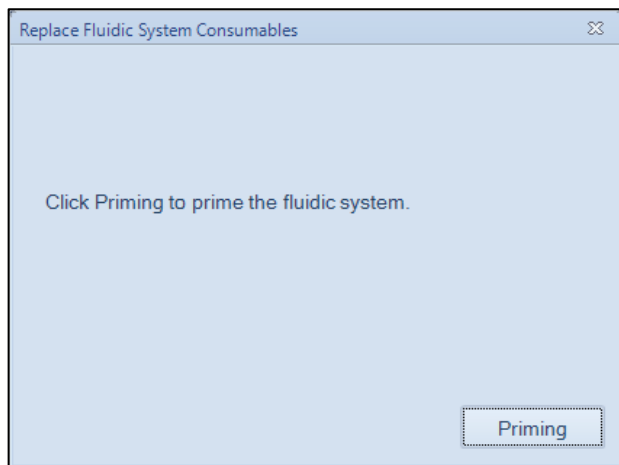

**Figure 94.** Software Message Instructing to Conduct Priming after Replacing Fluidic System Consumables

During the **Priming** procedure, the progress of the **Priming** will be shown below in the NovoExpress software.

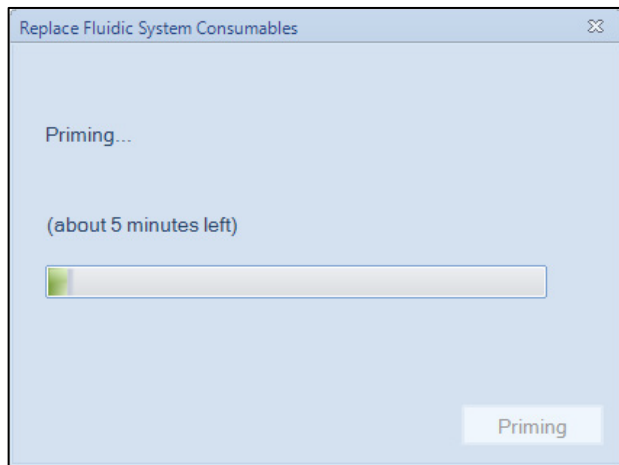

**Figure 95.** Software Message Indicating the Progress of Priming

### NOTE

The **Priming** procedure can also be manually initiated by clicking **Instrument > Fluidics Maintenance > Priming** on the NovoExpress software when the instrument is in **Ready** status.

## System Maintenance

Once the **Priming** procedure is completed, a dialog box below will be prompted for conducting the QC Test. Prepare the QC particle sample as described in [NovoExpress Software Guide](#) and place it in the tube holder. Click **QC Test** to initiate the QC Test. The QC Test will automatically start. Follow the steps and complete the QC Test. A QC Test must be conducted each time when fluidic system consumables are replaced in order to check the performance of the system.

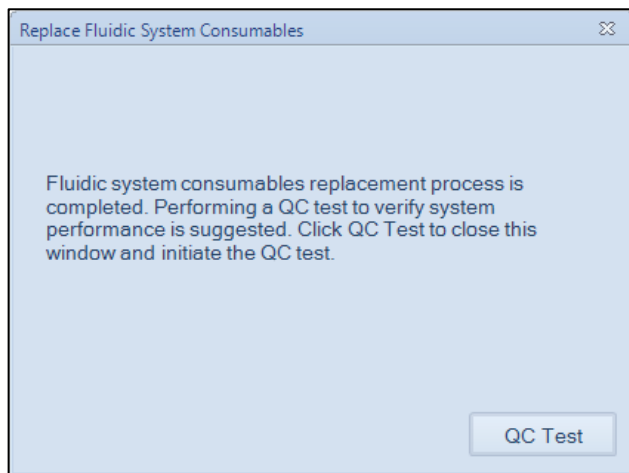

**Figure 96.** Software Message Instructing a QC Test after Completion of Fluidic System Consumables Replacement

The following sections describe the detailed procedure for replacing fluidic system consumables. It is highly recommended to replace all the fluidic system consumables at the same time to ensure the optimal system performance. However, each component can also be replaced individually if necessary. Click **Instrument > Replace Fluidic System Consumables** in the NovoExpress software to initiate the process. Always conduct the **Priming** process after the fluidic system consumables have been replaced as prompted by the NovoExpress software or manually conduct the **Priming** process by clicking **Instrument > Fluidics Maintenance > Priming**.

### Replace the NovoFlow Sheath Fluid In-Line Filter

- 1 Make sure the instrument is in **Ready** or shut down status.
- 2 Open the front panel of the instrument. Locate the sheath fluid in-line filter as shown below.

## System Maintenance

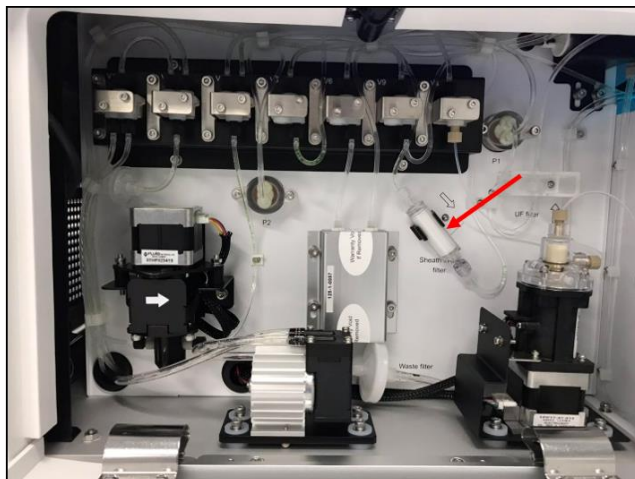

Figure 97. Location of Sheath Fluid In-line Filter

- 3 Unscrew the Luer connectors at two ends of the filter to disconnect the tubings from the filter.

### CAUTION

Use lint free wipes to gently wipe of the sheath fluid from the tubing and avoid sheath fluid dripping onto the instrument.

- 4 Replace the old filter with a new one and correctly connect the tubings to the filter.

### CAUTION

Finger tightening the Luer connectors only to avoid damage of the filters and filter leakage.

- 5 Once the instrument is **Ready**, click **Instrument > Fluidics Maintenance > Priming** to prime the fluidic system. Observe the sheath fluid flows through the filter properly and make sure there is no leakage through the filter-tubing connections.
- 6 Close the front panel. If the instrument is in shut down status, turn on the instrument, and automatic start-up cleaning process will be initiated. Observe the sheath fluid flows through the filter properly and make sure there is no leakage through the filter-tubing connections. Then run the **Priming** process when start-up process is completed and instrument is ready.

## System Maintenance

### CAUTION

The ends of the sheath fluid in-line filter are designed to be different on purpose to ensure the in-line filter is connected into the system in the correct direction. Incorrect direction would lead to system malfunction.

### CAUTION

When replacing the sheath fluid in-line filter, do not twist or kink the tubing.

### Replace the Waste Filter

- 1 Make sure the instrument is in **Ready** or shut down status.
- 2 Open the front panel of the instrument. Locate the waste filter as shown below.



Figure 98. Location of Waste Filter

- 3 Unscrew the Luer connectors at two ends of the waste filter to disconnect the tubings from the filter.

### CAUTION

Use lint free wipes to gently wipe of the sheath fluid from the tubing and avoid sheath fluid dripping onto the instrument.

- 4 Replace the old filter with a new one and correctly connect the tubing to the filter. Ensure the side of the filter labeled with "Inlet" is connected to the inlet tubing as shown below.

## System Maintenance

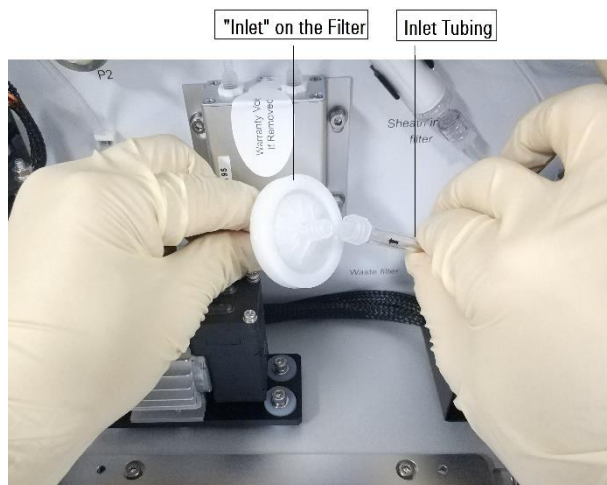

Figure 99. Connect the Waste Filter

### CAUTION

Finger tightening the Luer connectors only to avoid damage of the filters and filter leakage.

- 5 Close the front panel. If the instrument is in shut down status, turn on the instrument, and automatic start-up cleaning process will be initiated. Observe the sheath fluid flows through the filter properly and make sure there is no leakage through the filter-tubing connections. Then run the **Priming** process when start-up process is completed and instrument is ready.

### CAUTION

When replacing the waste filter, do not twist or kink the tubing.

### WARNING



All biological samples or materials can contain infectious deadly disease. Please be careful and always wear protective clothing, masks, and gloves when handling the waste.

### Replace NovoFlow Sheath Fluid Inlet Filter

NovoFlow sheath fluid inlet filter is placed inside the NovoFlow container to filter out micro-particles or impurities in the sheath fluid.

- 1 Make sure the instrument is in **Ready** or shut down status.



## System Maintenance

- 2 Press the metal clip on the quick coupler to disconnect the tubing from the NovoFlow sheath fluid container' cap.
- 3 Unscrew the cap and take the tubing-filter assembly (see figure below) out from the container and put it on a clean lint-free wipe.



**Figure 100.** NovoFlow Sheath Fluid Inlet Filter

- 4 Replace the old filter with a new one and correctly connect the tubing to the filter.

### NOTE

The procedures described above may vary if NovoCyte Fluidics Cart is used. Please refer to [NovoCyte Fluidics Cart Operator's Guide](#) for more details.

### CAUTION

**Please use proper force when tightening the Luer connectors.**

### CAUTION

**The ends of the sheath fluid inlet filter are different to ensure the filter is connected into the system in the correct direction. Incorrect installation will lead to system malfunction.**

- 5 Click **Instrument > Fluidics Maintenance > Priming** to prime the fluidic system.

### CAUTION

**When replacing the sheath fluid inlet filter, do not twist or kink the tubing.**

## Replace NovoRinse and NovoClean Solution Inlet Filter

NovoRinse and NovoClean solution inlet filters are placed inside the NovoRinse and NovoClean containers, respectively, to filter out micro-particles or impurities in the solution.

- 1 Make sure the instrument is in **Ready** or shut down status.
- 2 Press the metal clip on the quick coupler to disconnect the tubing from the NovoRinse or NovoClean container' cap.

## System Maintenance

- 3 Unscrew the cap and take the tubing-filter assembly (see figure below) out from the container and put it on a clean lint free wipe. Remove the old filter and replace with a new one.



Figure 101. NovoRinse and NovoClean Solution Inlet Filter

- 4 Click **Instrument > Fluidics Maintenance > Priming** to prime the fluidic system.

### Replace 0.05 µm Sheath Fluid Ultrafiltration (UF) Filter (Optional)

Agilent flow cytometer 0.05 µm Sheath Fluid Ultrafiltration Filter is an optional accessory of NovoCyte Quanteon flow cytometer for sterilizing and clarifying biological samples used on the instrument. It has 0.05 µm pore size which can reduce the background for small particles detection during sample acquisition. It is recommended to replace this filter every two weeks after the first time use by following the procedures below. These procedures can also be used when installing this filter is needed.

#### NOTE

Agilent flow cytometer 0.05 µm Sheath Fluid Ultrafiltration Filter is optional accessory which can be ordered separately. Please contact Agilent local sales representatives for the order information.

#### WARNING

**Please wear protective gloves and use proper precautions when conducting this procedure.**

- 1 Make sure the instrument is in **Ready** or shut down status.
- 2 Gently push and open the instrument front panel.
- 3 Locate the 0.05 µm Sheath Fluid Ultrafiltration (UF) Filter rack (Figure 102). Disconnect the tubing located inside the rack by unscrewing the Luer connectors if first time installation or remove the existing filter by unscrewing the Luer connectors at two ends of the filter if this filter is already installed.

#### NOTE

The instrument is shipped with the filter rack pre-installed.

## System Maintenance



**Figure 102.** Location of the 0.05 µm Sheath Fluid Ultrafiltration (UF) Filter rack

### CAUTION

**Use lint free wipes to gently wipe of the sheath fluid from the tubing and avoid sheath fluid dripping onto the instrument.**

- 4 Connect the outlet of the new filter to the female Luer connector, and the inlet of the new filter to the male Luer connector. Secure the filter onto the filter rack by gently sliding it through the open slit on the rack.

### CAUTION

**Ensure the filter is vertically mounted and all the tubing is not twisted.**

### NOTE

Under some situation when the Ultrafiltration Filter needs to be removed after initial installation, disconnect the filter from the Luer connectors and connect the male Luer connector directly to the female one.

## System Maintenance

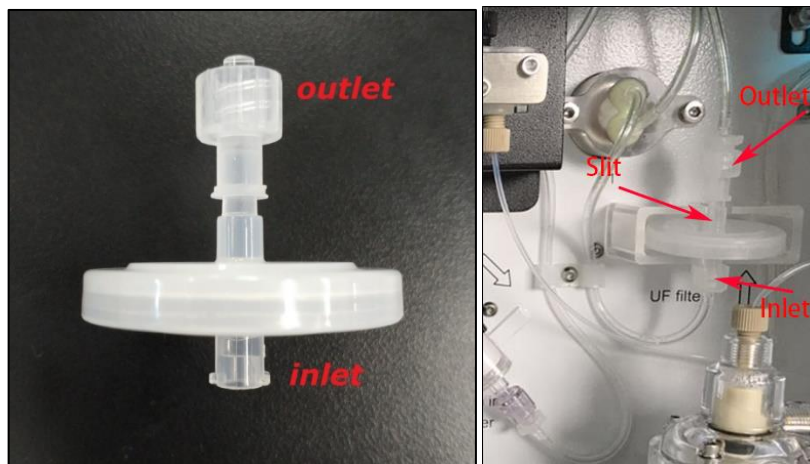

**Figure 103.** Properly Installed 0.05 µm Sheath Fluid Ultrafiltration (UF) Filter

- 5 Open NovoExpress software. Click **Instrument > Fluidic Maintenance > Priming** to prime the fluidic system. Ensure no fluidic leakage from the filter's inlet/outlet.
- 6 Load a sample tube with 1 mL Milli-Q or 0.2 µm filtered DI water onto the tube holder. Create a new experiment. Set **Stop Condition** as 500 µL and **Flow Rate** as 120 µL/min. Click the **Run** button in **Experiment Control** panel to start the sample acquisition. This step is to flush sample tubing.
- 7 Close the front panel. The installation is completed, and the instrument is ready to use.

## Unscheduled Maintenance

The following instrument components should be checked occasionally, and maintenance or cleaning should be conducted when necessary. The frequency depends on how often the instrument is used. Other components not listed here should also be checked periodically for wear and replacement if necessary.

**Table 10** Unscheduled Maintenance and When to Perform

Unscheduled Maintenance	When to Perform
Debubble	<ul style="list-style-type: none"> <li>The CV of the data is larger than normal.</li> <li>QC test failed.</li> <li>No events showed up after sample collection started for certain period of time.</li> <li>Instrument was not used for over one week.</li> </ul>
Clean the External Surface of the Instrument	Keep the external surface of the instrument clean.
Decontamination	When suspecting contamination in the system.
Prime Fluidics System before Long-Term Storage	No plan to run the instrument for more than two weeks.
Prime Fluidics System after Long-Term Storage	Instrument has not been used for more than two weeks.
Purge Fluidics System before Shipment	The instrument needs to be shipped.
Calibrate the NovoCyte Fluidics Station II or NovoCyte Fluidics Cart	Abnormal warning about the liquid level in the reagent containers is observed.
Clean the Optical Filters	The optical filters get dirty.
Clean Fluidics System	<ul style="list-style-type: none"> <li>The CV of the data is larger than normal.</li> <li>QC test failed.</li> <li>Excessive debris in display.</li> </ul>

### Debubble

When the CV of the data is larger than normal or the QC Test fails, there is a possibility that bubbles exist inside the flow cell. In this case, the following procedure should be conducted to remove the bubbles.

When the instrument is in **Ready** status, click **Instrument > Fluidics Maintenance > Debubble** from the NovoExpress software to execute the **Debubble** procedure.



## System Maintenance

Figure 104. Debubble Function in NovoExpress

### Clean the External Surface of the Instrument

Keep the external surface of the instrument clean using the following method.

- 1 Turn off the power of the instrument and unplug the power cord.

**WARNING**



**To avoid the risk of electrical shock, make sure to power off the instrument and unplug the power cord from the power outlet.**

- 2 Gently wipe the surface of the instrument with a clean soft cloth soaked with NovoRinse solution (1X).
- 3 Wipe the surface again using a clean soft cloth.
- 4 Reconnect the power cord of the instrument.

**WARNING**

**The surface of the instrument may be contaminated by biological samples which may be biohazardous. Ensure to wear appropriate personal protective equipment (e.g. gloves, clothing, and eyewear) when cleaning the surface.**

**CAUTION**

**Do not use isopropyl alcohol (IPA) or ethanol to clean the instrument surface.**

### Decontamination

The decontamination procedure can be used either after a known contamination has occurred, or as a preventative maintenance procedure to minimize or prevent the occurrence of contamination in the fluidics system.

**NOTE**

A Decontamination Kit is required to run this procedure. Please consult with Agilent local representative for ordering information for your product.

**NOTE**

The **Decontamination** function is only available when **Decontaminate Instrument** privilege is enabled. Refer to [NovoExpress Software Guide](#) for instructions to enable this privilege.

- 1 Click **Instrument > Fluidics Maintenance > Decontamination** from the NovoExpress software.

## System Maintenance



Figure 105. Decontamination Function in NovoExpress

- 2 NovoExpress software will prompt a dialog box to guide you through the decontaminating procedure. Follow the instructions in each step and click **OK** to move to the next step until completion.

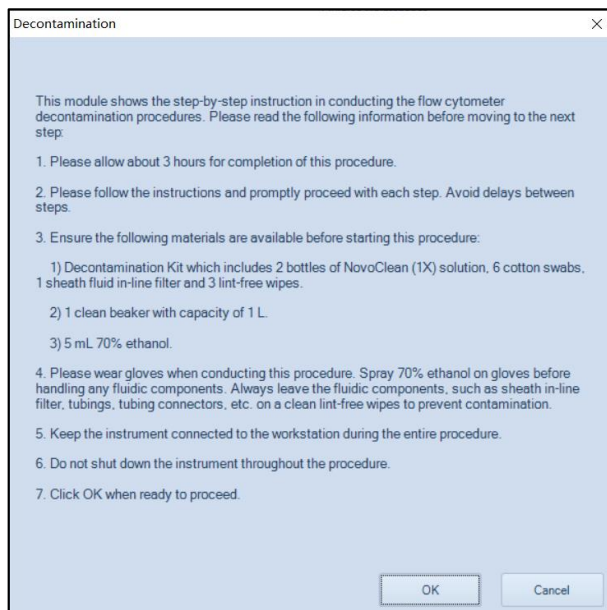

Figure 106. NovoExpress Dialog Box to Guide the Decontamination Procedure

### NOTE

Contact your local Agilent representative or distributor for any questions regarding this procedure.

## Prime Fluidic System before Long-Term Storage

If there is no plan to run the instrument for more than two weeks, a thorough cleaning process is recommended to prevent salt crystallization in the fluidic system.

- 1 When the instrument is in **Ready** status, replace all the instrument reagents with Milli-Q or 0.2  $\mu\text{m}$  filtered DI water.

## System Maintenance

- Click **Instrument > Fluidics Maintenance > Priming** from the NovoExpress software. Repeat the procedure two times.



**Figure 107.** Priming Function in NovoExpress

- Press the power switch on the front panel of the instrument to initiate the automatic shutdown cleaning process.
- After the shutdown cleaning process is completed, the instrument will power off automatically. The NovoExpress software status bar will show **Instrument not Connected** message.
- Empty all the reagent containers and empty the waste. Rinse the containers with Milli-Q or 0.2  $\mu\text{m}$  filtered DI water thoroughly and air dry.

### Prime Fluidic System after Long-Term Storage

If the instrument has not been used for more than two weeks, a thorough cleaning process is also recommended before using the instrument to ensure the fluidic system is working in optimal condition.

- Sterilize the reagent containers following the procedure described in [Sterilize Instrument Reagent Containers](#) of this guide.
- Add NovoFlow, NovoRinse, and NovoClean to the corresponding containers.
- Press the power button on the front panel of the instrument. The instrument will start the automatic start-up cleaning procedure.
- Click **Instrument > Fluidics Maintenance > Priming** from the NovoExpress software. Repeat the procedure two times.

#### NOTE

If the instrument has not been used for more than two months, it is also recommended to replace the fluidic system consumables before use. Refer to [Replacing Fluidic System Consumables](#) in this guide for detailed procedure.

### Purge Fluidic System before Shipment

If for any reason the instrument needs to be shipped or relocated, perform the following procedure to purge the fluidic system before packaging and shipping



## System Maintenance

### NOTE

The **Purge** function is only available when the **Purge Instrument** privilege is enabled. Refer to [NovoExpress Software Guide](#) for instructions to enable this privilege.

- 1 Click **Instrument > Fluidics Maintenance > Purge** from the NovoExpress software.



Figure 108. Purge Function in NovoExpress

- 2 NovoExpress software will prompt a dialog box to guide you through the purging procedure. Follow the instructions in each step and click **OK** to move to the next step until completion.

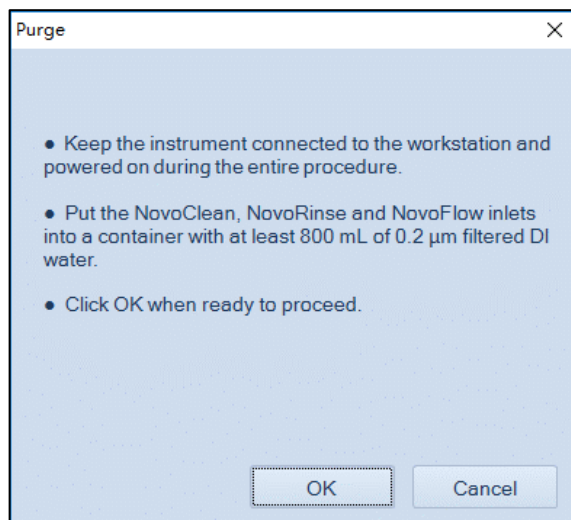

Figure 109. Software Message When Starting the Purge Procedure

- 3 Power off the instrument. Unplug the power supply and accessories.
- 4 Sterilize the reagent containers following the procedure described in [Sterilize Instrument Reagent Containers](#) of this guide.
- 5 Pack the instrument and accessories properly for shipment.

### CAUTION

**If there are operating questions when purging the fluidics system, in order to avoid damaging the instrument, please stop purging and contact your local Agilent representative or distributor.**

## System Maintenance

### Calibrate NovoCyte Fluidics Station II

NovoCyte Fluidics Station II is calibrated at the factory and should be ready to use when connected to the instrument after installation. However, in some cases when there is a need to recalibrate the fluidics station after shipment and movement (e.g. when a false warning about the liquid level in the reagent containers is observed), follow the procedures below to recalibrate the fluidics station.

#### NOTE

**Calibrate Fluidics Station** function is only available when **Calibrate Fluidics Station** privilege is enabled. Refer to [NovoExpress Software Guide](#) for instructions to enable this privilege.

- 1 Click **Instrument > Operation > Calibrate Fluidics Station** in the NovoExpress software.



**Figure 110.** Calibrate Fluidics Station Function in NovoExpress

- 2 Follow the instruction in the software, remove the NovoFlow, NovoRinse, NovoClean, and waste containers from the fluidics station. Click the **OK** button.

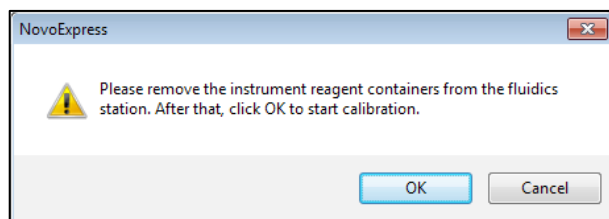

**Figure 111.** Software Message Instructing to Start Fluidics Station Calibration

- 3 The software will prompt a dialog box indicating the fluidics station calibration is successful. Follow the instructions to place the NovoFlow, NovoRinse, NovoClean, and waste containers back into the fluidics station. Click the **OK** button.

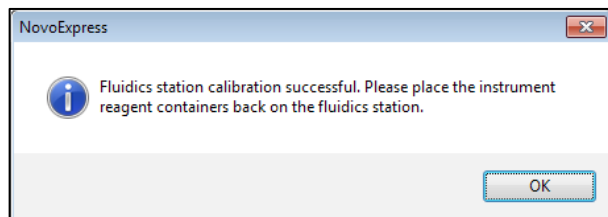

**Figure 112.** Software Message Indicating Fluidics Station Calibration is Successful

### Clean the Optical Filters

In normal operation, the optical filters are tightly enclosed inside the optical fixtures and should remain clean. However, it might get dirty if removed from the slot or during replacement. The following method describes how to clean the optical filters when it gets dirty. Maintaining the optical filters surface clean is very important to get the optimal data.

#### CAUTION

**When cleaning or replacing optical filters, handle with care to avoid scratching the surface and to prevent the filters from falling out of the holder. Use cotton swabs, optical lens paper, and spectral-grade methanol or analytical grade ethanol in a dropper bottle to clean the optical filters. Acetone should not be used for cleaning the optical filters. Always wear laboratory gloves when handling the optical filter.**

- 1 Open the top cover of the instrument. Insert one end of the Allen wrench through the hole of optical filter. Gently hold the proper optical filter and pull it upward to remove it from the slot (Figure 29).
- 2 Blow off the contaminants on the surface of optical filters. Many contaminants are just loosely attached to the surface of the optical filters and can be blown off. Hold the filter firmly in one hand. Always use a gentle to moderate air flow and maintain an oblique angle. Slowly move the air stream over the filter surface at an angle to gently blow off the contaminants. Repeat this process for the other side of the filter.
- 3 Wrap a triangular-shaped lint-free wipe or lens cleaning tissue around a lint-free cotton swab. Moisten and seal the end with a few drops of anhydrous alcohol.
- 4 Holding the cotton swab in a horizontal position, gently clean the surface of the filter with a continuous motion in one direction at a constant speed.
- 5 Allow the solvent to evaporate. Use a room light to inspect the filter to ensure it is clean. If contamination remains, start with a brand-new wipe and swab and repeat Step 3-4 again.
- 6 Repeat Step 3-5 to clean the other side of the filter.
- 7 Insert the cleaned filter back into the filter slot according to the correct orientation and push it all the way in (Figure 29).
- 8 Close the top cover of the instrument.

## System Maintenance

### CAUTION

Always blow the contaminants off the filters before using the wipe or swab to clean the filter surface. Failure to do so may scratch the filter surface.

### CAUTION

Do not reuse the wipes and swabs. Always use new wipes and swabs for every new cleaning attempt.

## Clean Fluidic System

When the CV of the data is larger than normal or the QC Test fails or excessive debris appears, it is possible that the flow cell or sampling tubing is dirty. In this case, the following procedure should be conducted to clean the flow cell or the sampling tubing.

When the instrument is in **Ready** status, click **Instrument > Fluidics Maintenance > Cleaning** from the NovoExpress software to execute the Cleaning procedure.



**Figure 113.** Cleaning Function in NovoExpress

# 7 Troubleshooting

This chapter describes general instrument troubleshooting and diagnostic guidelines.

**NOTE**

For technical support, please refer to [Technical Support](#) in this guide.

Table 11 provides guidance on troubleshooting NovoCyte Quanteon instrument and associated accessories.

For complete list of NovoExpress software prompted error or warning messages when operating Agilent flow cytometer and associated accessories, please refer to [NovoExpress Software Guide](#).

**NOTE**

Please contact Agilent Technical Support if issues are not resolved after performing the recommended solutions or if there are any issues which are not listed in these two tables.

**NOTE**

Investigate possible causes and perform the recommended solutions in the given order.

**Table 11 Instrument Troubleshooting Guide**

Observation	Possible Causes	Recommended Solutions
Instrument QC test fails	QC particles are expired or not stored properly	Prepare a new tube of QC particles and mix them well to run the QC test again.
	Flow cell is clogged	Execute <b>Unclog</b> function from the NovoExpress software.
	Flow cell is dirty	Execute <b>Cleaning</b> function from the NovoExpress software.
Zero or low number of events detected	Air bubbles exist in the flow cell	Execute <b>Debubble</b> function from the NovoExpress Software.
	Threshold is set too high	Lower the threshold setting and re-collect the sample.
	Sample concentration is too low	Redo sample preparation using an appropriate method to concentrate the sample.
	Sample did not mix well	Mix the sample well to suspend the cells.

## Troubleshooting

	NovoFlow container is empty	Refill the NovoFlow container following the procedures described in associated instrument operator's guide.
	NovoFlow container is not correctly connected to the instrument and the NovoFlow solution does not flow through the tubing	Reconnect the NovoFlow quick coupling connectors to ensure the NovoFlow container is correctly connected to the instrument. Execute <b>Prime</b> function from the NovoExpress Software.
	Sample Injection Probe is clogged	Run NovoClean as sample to remove the things clogged in SIP.
	Flow cell is clogged	Execute the <b>Unclog</b> function from the NovoExpress Software.
	Sample tubing is leaking	Clean the leaked fluid with wipes and properly reconnect the sample tubing.
	Air bubbles exist in the Sampling Pump	Execute <b>Debubble</b> function from NovoExpress Software.
High CV	Air bubbles exist in the flow cell	Execute the <b>Debubble</b> function from NovoExpress Software.
	Flow cell is clogged	Execute the <b>Unclog</b> function from NovoExpress software
	Improper sample preparation	Re-prepare the sample properly.
	The sample flow rate is set too high	Lower the sample flow rate setting in the NovoExpress software.
Excessive debris in display	Sheath in-line filter is dirty	Replace the sheath in-line filter following the procedures described in associated instrument operator's guide.
	The threshold is set too low	Increase the threshold setting and re-collect the sample.
	Fluidics system tubing is dirty	<ul style="list-style-type: none"> <li>Execute <b>Rinse</b> function from NovoExpress Software.</li> <li>Execute <b>Cleaning</b> function from NovoExpress Software.</li> <li>Execute <b>Decontamination</b> function from NovoExpress Software.</li> </ul>
High event rate	The threshold is set too low	Increase the threshold setting and re-collect the sample.
	Sample concentration is too high	Re-prepare the sample to appropriate concentration or dilute the sample.
	Sample flow rate is too high	Reduce the sample flow rate.
NovoExpress displays <b>Instrument</b>	Workstation is in hibernation causing the interruption of	<ul style="list-style-type: none"> <li>Restart NovoExpress Software.</li> <li>Restart workstation.</li> </ul>

## Troubleshooting

not connected even though the instrument is powered up	communication between the instrument and workstation	
	Improper connection between the instrument and workstation	Reconnect the USB cable between the instrument and the workstation.
	More than one NovoExpress instances are running	Only run one instance of NovoExpress software.
Unstable Signal or gap in the data plot	Air bubbles exist in the flow cell	Execute the <b>Debubble</b> function from NovoExpress Software.
Sample tube does not fit the sample tube holder	Wrong type of sample tube is used	Use 12 × 75 mm tube or 1.5 mL tube 2.0 mL tube.
Sample Injection Probe is not properly aligned with the wells or tubes	Plate or tube rack is not loaded correctly.	Load the plate or tube rack with the correct orientation. Make sure the plate or tube rack is fully seated onto the sample tray properly.
	NovoSampler (or NovoSampler Pro or NovoSampler Q) is not calibrated.	Re-calibrate the NovoSampler (or NovoSampler Pro or NovoSampler Q). Refer to associated operator's guide for more details.
Leakage from the SIP	Waste tubing is deformed	<ul style="list-style-type: none"> <li>Reconnect the waste tubing to ensure it is properly connected.</li> <li>Move the instrument forward as needed to ensure sufficient space between the instrument and wall. Refer to associated instrument operator's guide for more information on properly installing instrument.</li> </ul>
	Waste filter is clogged	Replace the waste filter following the procedures described in associated instrument operator's guide.
Leakage from Sampling Pump	Incorrect tubing connection to the sampling pump	Reconnect the tubing to the sampling pump.
Leakage from other components of the instrument	Incorrect pump or valve or tubing connection or bad sheath in-line filter	Turn off the instrument and contact Agilent technical support for assistance.

## Troubleshooting

This page is intentionally left blank.



## 8 Version History

**Table 12** History of updates

<b>Date/Version</b>	<b>Changed by</b>	<b>Description</b>
08/31/2018		Initial Release
10/31/2019		Second Edition
03/31/2021		Third Edition

## Version History

This page is intentionally left blank.

# Appendix A: NovoCyte Quanteon Laser and Detection Channel Configuration

This chapter provides additional information on NovoCyte Quanteon laser and detection channel configuration.

## Laser Configuration

NovoCyte Quanteon standard systems offers four lasers (405 nm, 488 nm, 561 nm, 637 nm) with 561 nm laser for FSC and SSC detection for each instrument to meet the needs for different applications. Customized optical configuration is available. Please contact your local Agilent Biosciences representatives or distributors for more details.

Table 13 lists the typical detectable fluorochromes on NovoCyte Quanteon standard systems.

**Table 13 Laser Wavelength and Detectable Fluorochromes on NovoCyte Quanteon**

Laser Wavelength (nm)	Typical Fluorescent Fluorochromes
405	Pacific Blue, AmCyan, Pacific Orange, Qdot 605, Qdot 655, Qdot 800, BV711
488	FITC, EYFP, PI, PerCP, PerCP-Cy5.5, PerCP-eFluor710
561	PE, PE-Texas Red, PE-Cy5, PE-Cy5.5, PE-Alexa Fluor 700, PE-Cy7
637	APC, Alexa Fluor 680, Alexa Fluor 700, APC-Cy7

## Detection Channel Configuration

Table 14 lists the optical filters used in the NovoCyte Quanteon System standard configurations and the recommended fluorochromes for each detector.

## NovoCyte Quanteon Laser and Detection Channel Configuration

**Table 14 Dichroic Mirrors and Bandpass Filters for NovoCyte Quanteon System<sup>1</sup>**

Excitation Laser	Detector	Dichroic Mirror	Bandpass Filter	Typical Fluorochrome
561 nm	Forward Scatter (FSC)	-	561/14	-
	Side Scatter (SSC)	552 LP	561/14	-
	Y586	570 SP	586/20	PE
	Y615	598 SP	615/20	PE-Texas Red
	Y660	685 LP	660/20	PE-Cy5
	Y667		667/30	
	Y695	705 LP	695/40	PE-Cy5.5
	Y725	FRM	725/40	PE-Alexa Fluor 700
	Y780	757 LP	780/60	PE-Cy7
405 nm	V445	495 LP	445/45	Pacific Blue
	V525	552 LP	525/45	AmCyan
	V530		530/30	
	V586	570 SP	586/20	Pacific Orange
	V615	598 SP	615/20	Qdot 605
	V660	685 LP	660/20	Qdot 655
	V667		667/30	
	V695	705 LP	695/40	Qdot 705
	V725	FRM	725/40	BV711
	V780	757 LP	780/60	Qdot 800
488 nm	B525	552 LP	525/45	FITC
	B530		530/30	
	B586	570 SP	586/20	EYFP
	B615	598 SP	615/20	PI
	B660	685 LP	660/20	PerCP
	B667		667/30	
	B695	705 LP	695/40	PerCP-Cy5.5
	B725	FRM	725/40	PerCP-eFluor 710
	B780	757 LP	780/60	PE-Cy7

## NovoCyte Quanteon Laser and Detection Channel Configuration

**Table 14 Dichroic Mirrors and Bandpass Filters for NovoCyte Quanteon System<sup>1</sup>**

637 nm	R660	685 LP	660/20	APC
	R667		667/30	
	R695	705 LP	695/40	Alexa Fluor 680
	R725	FRM	725/40	Alexa Fluor 700
	R780	757 LP	780/60	APC-Cy7

<sup>1</sup>Certain fluorescence detection channels, bandpass filters or dichroic mirrors may not be included in your NovoCyte Quanteon system. Please consult with your local Agilent sales representatives or distributors for more details.

## NovoCyte Quanteon Laser and Detection Channel Configuration

This page is intentionally left blank.

# Appendix B: NovoCyte Quanteon Technical Specifications

This chapter provides technical specifications of NovoCyte Quanteon flow cytometer and associated standard accessories.

## NovoCyte Quanteon Technical Specifications

**Table 15 NovoCyte Quanteon Technical Specifications<sup>1</sup>**

<b>Optics</b>	<b>Laser</b>	Solid state laser with on-board thermal-electric cooling and guaranteed thermal stability and beam quality
	<b>Laser Power</b>	100 mW
	<b>Laser Beam Profile</b>	10 x 60 µm elliptical beam
	<b>Optical Alignment Procedure</b>	Fixed, no operator alignment required
	<b>Fluorescence Detection</b>	Silicon Photomultiplier (SiPM) with high photon detection efficiency; Individual photodetector for each channel
	<b>FSC/SSC Sensitivity</b>	FSC: 0.4 µm; SSC: 0.1 µm
	<b>Fluorescence Resolution</b>	<3% CV for CEN
	<b>Optical Filters</b>	User exchangeable, "Smart" filter automatically read by the system
	<b>Cell Size</b>	0.1 - 50 µm
<b>Fluidics</b>	<b>Flow Cell</b>	170 x 290 µm rectangular quartz flow cell
	<b>Sample Acquisition Rate</b>	100,000 events/second
	<b>Sample Delivery</b>	Positive-displacement syringe pump enabling direct absolute count without the need for reference counting beads.
	<b>Volumetric Absolute Count Precision</b>	< 5%

## NovoCyte Quanteon Technical Specifications

**Table 15 NovoCyte Quanteon Technical Specifications<sup>1</sup>**

	<b>Sample Flow Rate</b>	5-120 $\mu$ L/min, continuously adjustable
	<b>Average Sheath Flow Rate</b>	6.5 mL/min
	<b>Sample Aspiration Volume</b>	5 $\mu$ L -5 mL
	<b>Sample Recovery</b>	Available
	<b>Compatibility to Autosampler</b>	No fluidic tubing disassembly or re-connection required.
	<b>Fluid Level Sensing</b>	Active sensing using weight sensors with automated warnings when any fluid level is out of specified range.
	<b>Fluid Container Capacity</b>	3 L sheath, 3 L waste, 500 mL cleaning, 500 mL rinse. Optional large container for sheath (15 L) and waste (15 L) with Fluidics Cart.
	<b>Carryover</b>	< 0.1%
	<b>Sample Injection Probe (SIP) Rinse</b>	Automated flying collar wash of inner and outer SIP surface after each sampling.
	<b>Fluidics System Monitoring</b>	In-line pressure sensor monitors the pressure in real time. Automated system recovery when pressure is out of range due to clogging.
	<b>Fluidics Maintenance</b>	Automated startup and shutdown with fluidic system cleaning. Automated user executable cleaning, debubble, rinse, unclog, priming and decontamination. Automated execution of user definable maintenance sequence.
<b>Data Acquisition</b>	<b>Software</b>	NovoExpress
	<b>Parameters</b>	Height and Area for FSC, SSC and all Fluorescent Channels, Width off FSC and Time.
	<b>Dynamic Range</b>	24 bits; 7.2 decades logarithmic scale
	<b>Fluorescence Photodetector Gain Control</b>	0-1000 User adjustable, optimized default gain setting for each individual channel.
	<b>Compensation</b>	Full inter-beam matrix, during or post acquisition.
	<b>File Export</b>	FCS 3.0, FCS 3.1; CSV; Batch PDF report
	<b>Data Report</b>	Automatic report. Customizable report. Batch PDF report.
	<b>Usage Monitor</b>	Comprehensive Transaction Log and System Log.



## NovoCyte Quanteon Technical Specifications

**Table 15 NovoCyte Quanteon Technical Specifications<sup>1</sup>**

	<b>User Management</b>	Administrative creation of individual user accounts and user groups with privilege control. Configurable roles for individual users. User operation time tracking.
<b>Quality Control</b>	<b>Instrument Daily QC</b>	Automatic daily quality control with Agilent Flow Cytometer QC Particles. Levi-Jennings Plot.
	<b>Production QC</b>	Each instrument is verified for assembly integrity and performance to specifications.
<b>Sampling</b>	<b>Manual Sample Loading</b>	12 X 75 mm tube, 1.5 mL or 2.0 mL tube with Agilent tube holder.
	<b>Automatic Sample Loading with NovoSampler Q</b>	Agilent Flow Cytometer 40 tube rack for 12 x 75 mm tube, 24-well, 48-well, 96-well (flat, V-, U-bottom), 384-well microtiter plates, Agilent Flow Cytometer 24 tube cooling rack for 12 x 75 mm tube, Agilent Flow Cytometer 96-well (flat, U-, V-bottom) plate cooling box.
<b>Operating Conditions</b>	<b>Instrument Dimension (W x D x H)</b>	24.4 x 18.1 x 18.8 in (62.0 x 46 x 48.0 cm) 33.5 x 18.1 x 18.8 in (85.0 x 46.0 x 48.0 cm) with NovoSampler Q
	<b>Instrument Weight</b>	104.0 lb (47.0 kg) 133.0 lb (60.0 kg) with NovoSampler Q
	<b>Operating Environment</b>	Temperature: 15-32°C, Relative Humidity: 80% maximum, Atmosphere Range: 76-106 kPa
	<b>Storage Environment</b>	Temperature: 1-40°C, Relative Humidity: 80% maximum
	<b>Power Requirements</b>	100-240 VAC, 50-60 Hz
<b>Regulatory Compliance</b>	<b>Indoor and Outdoor Use</b>	Indoor use only
	<b>Overvoltage Category</b>	Class II
	<b>Equipment Class</b>	Class I Laboratory Equipment
	<b>Pollution degree of the intended environment</b>	2
	<b>Degree of Ingress protection</b>	IPX0

<sup>1</sup>Specification and performance claims would be based on certain specific experiment conditions.

## NovoCyte Workstation and Monitor Specifications

**Table 16 NovoCyte Workstation and Monitor Specifications**

<b>NovoCyte Workstation</b>	Small form factor (SFF). Intel Core i7 CPU or above, 16G RAM or above, 512G sold state drive or above.
<b>Monitor</b>	High resolution flat panel with resolution of 1,920 x 1,080 or above
<b>Computer Operating System</b>	Microsoft Windows 10 Professional (64 bit) or above with Microsoft Office and NovoExpress software pre-installed

## NovoCyte Fluidics Station II Specifications

**Table 17 NovoCyte Fluidics Station II Specifications**

<b>Dimensions (with reagents containers) (W × D × H)</b>	11.4 × 9.8 × 16.5 in (29.0 × 25.0 × 42.0 cm)
<b>Weight</b>	14.1 lb (6.4 kg)
<b>NovoFlow sheath fluid container</b>	3 L
<b>NovoClean solution container</b>	500 mL
<b>NovoRinse solution container</b>	500 mL
<b>Waste container</b>	3 L



# In This Guide

The manual describes the following:

- Prologue
- Introduction
- Installation
- Instrument Operation
- Running Samples
- System Maintenance
- Troubleshooting
- Version History
- Appendix A: NovoCyte Quanteon Laser and Detection Channel Configuration
- Appendix B: NovoCyte Quanteon Technical Specifications

[www.agilent.com](http://www.agilent.com)

© Agilent Technologies, Inc. 2021

Third Edition, March 2021



150135

